

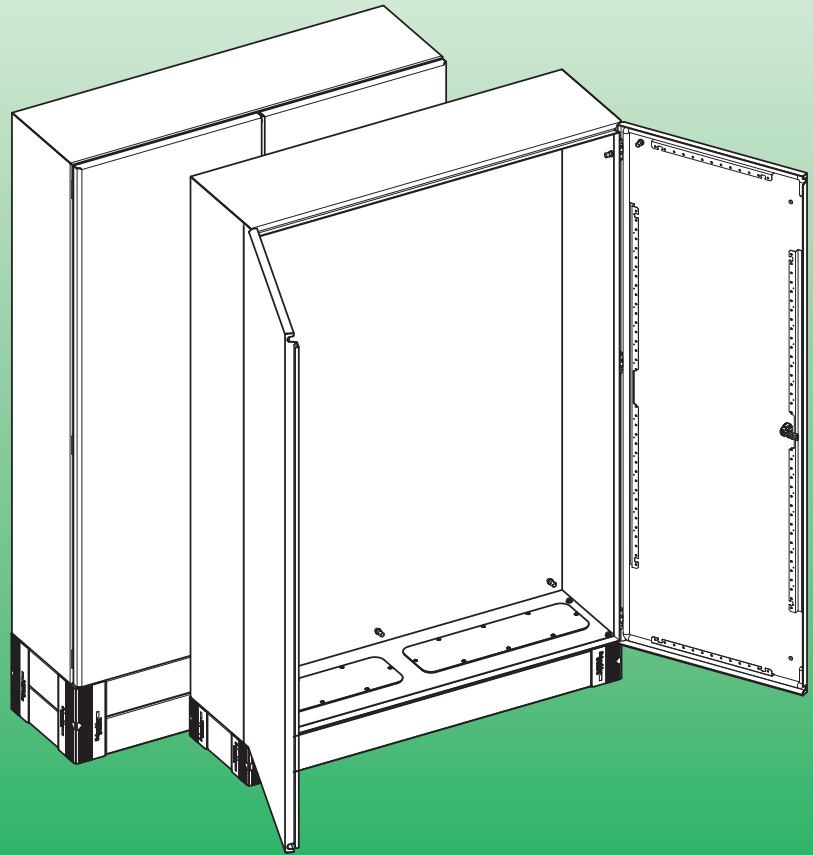





PanelSeT S3D CRN

- en** Plinth for PanelSeT Wall-mounted Enclosure
- fr** Socle coffret mural PanelSeT
- es** Zócalo para Armario mural PanelSeT
- de** Sockel für Wandschrank PanelSeT



 type 1 M6 / T30 3 Nm 26,55 lb-in	 type 2 M6 3 Nm 26,55 lb-in	 type 3 M6 3 Nm 26,55 lb-in	 type 4 M5 1,3 Nm 11,50 lb-in	 type 5 diam. 6	 type 6 diam. 13
---	---	---	---	---	--

⚠ CAUTION / ATTENTION / ATENCIÓN / VORSICHT / ATTENZIONE / CUIDADO / 小心 / ВНИМАНИЕ	
HAZARD OF EQUIPMENT DAMAGE Respect the information provided in the instruction to ensure the functioning of the product. Failure to follow these instructions can result in injury or equipment damage.	RISQUE DE DETERIORATION DU MATERIEL Respecter les informations fournies sur la notice pour garantir le fonctionnement du produit. Si ces directives ne sont pas respectées, cela peut entraîner des blessures ou des dommages matériels.
RIESGO DE DETERIORO DEL MATERIAL Respetar la información proporcionada en las instrucciones para garantizar el funcionamiento del producto. El incumplimiento de estas instrucciones puede causar lesiones o daño al equipo.	GEFAHR VON MATERIALSCHÄDEN Beachten Sie die Angaben in der Betriebsanleitung zur Verfügung gestellt, um die Funktionsweise des Produkts zu gewährleisten. Die Nichtbeachtung dieser Anweisungen kann Verletzungen oder Sachschäden zur Folge haben.
RISCHIO DI DANNI ALLE APPARECCHIATURE Rispettare le istruzioni fornite per garantire il funzionamento del prodotto. Il mancato rispetto di queste istruzioni può provocare infortuni o danni alle apparecchiature.	RISCO DE DETERIORAÇÃO DO MATERIAL Respeitar as informações fornecidas no manual de instruções para assegurar o funcionamento do produto. A não observância destas instruções pode provocar ferimentos pessoais, ou danos no equipamento.
设备受损风险 为保证正常使用该产品请仔细阅读本产品说明书。 不遵循上述说明可能导致人身伤害或设备损坏。	ОПАСНОСТЬ ПОВРЕЖДЕНИЯ ОБОРУДОВАНИЯ Следуйте информации, указанной в инструкции, для гарантии правильного функционирования продукта. Несоблюдение этих инструкций может привести к травме или повреждению оборудования.

