

EcoStruxure™ EV Charging Expert

User Guide

04/2026



Legal information

The information provided in this document contains general descriptions, technical characteristics and/or recommendations related to products/solutions.

This document is not intended as a substitute for a detailed study or operational and site-specific development or schematic plan. It is not to be used for determining suitability or reliability of the products/solutions for specific user applications. It is the duty of any such user to perform or have any professional expert of its choice (integrator, specifier or the like) perform the appropriate and comprehensive risk analysis, evaluation and testing of the products/solutions with respect to the relevant specific application or use thereof.

The Schneider Electric brand and any trademarks of Schneider Electric SE and its subsidiaries referred to in this document are the property of Schneider Electric SE or its subsidiaries. All other brands may be trademarks of their respective owner.

This document and its content are protected under applicable copyright laws and provided for informative use only. No part of this document may be reproduced or transmitted in any form or by any means (electronic, mechanical, photocopying, recording, or otherwise), for any purpose, without the prior written permission of Schneider Electric.

Schneider Electric does not grant any right or license for commercial use of the document or its content, except for a non-exclusive and personal license to consult it on an "as is" basis.

Schneider Electric reserves the right to make changes or updates with respect to or in the content of this document or the format thereof, at any time without notice.

To the extent permitted by applicable law, no responsibility or liability is assumed by Schneider Electric and its subsidiaries for any errors or omissions in the informational content of this document, as well as any non-intended use or misuse of the content thereof.

About this guide

Document scope

The purpose of this guide is to provide installers, maintenance personnel and users with the technical information necessary to install, commission and use the EcoStruxure EV Charging Expert.

Introduction

- EcoStruxure EV Charging Expert main features:
 - allocate a current setpoint to the charging stations in operation
 - see in real time the status of the charging stations through the dashboard
 - manage user authentication for charging authorization
 - get the charging sessions history and data from the charging stations in the network
- EcoStruxure EV Charging Expert is compatible with remote supervision from a Charge Point Operator in OCPP 1.6 Json.
- EcoStruxure EV Charging Expert allows two access profiles:

Admin: Access to all configuration parameters and features, dashboard operation and RFID cards management.

User: Dashboard operation.

Related documents

Title of documentation	Reference number
eMobility Infrastructure Design guide for building applications	EVSOL1DG001EN
Instructions sheet for Acti9 Smartlink SI D gateway A9XMWA20 (English, Dutch, French, German, Italian, Portuguese, Spanish, Chinese, Russian)	NVE60007
Instructions sheet for power meter METSEPM5320 (English, Dutch, French, German, Italian, Portuguese, Spanish, Chinese, Russian)	HRB69887
Instructions sheet for power meter A9MEM3250 (English, Dutch, French, German, Italian, Portuguese, Spanish, Chinese, Russian)	NHA15795
Instructions sheet for Enerlin'X IFE gateway LV434002 (English, French)	DOCA0084
Instructions sheet Enerlin'X EIFE communication module LV851001 (English, French)	DOCA0106
Installation guide for EcoStruxure EV Charging Expert (English)	DOCA0164EN
EcoStruxure EV Charging Expert - Rest API	EVINBEMS
eMobility Infrastructure – Commissioning Guide	EVSOLCG001EN

You can download these technical publications and other technical information from our website at <https://www.se/en/download>

Trademarks

QR Code is a registered trademark of DENSO WAVE INCORPORATED in Japan and other countries.

Safety information

Important information

Read these instructions carefully, and look at the equipment to become familiar with the device before trying to install, operate, service, or maintain it. The following special messages may appear throughout this documentation or on the equipment to warn of potential hazards or to call attention to information that clarifies or simplifies a procedure.



The addition of this symbol to a “Danger” or “Warning” safety label indicates that an electrical hazard exists which will result in personal injury if the instructions are not followed.



This is the safety alert symbol. It is used to alert you to potential personal injury hazards. Obey all safety messages that follow this symbol to avoid possible injury or death.

DANGER

DANGER indicates a hazardous situation which, if not avoided, **will result in** death or serious injury.

WARNING

WARNING indicates a hazardous situation which, if not avoided, **could result in** death or serious injury.

CAUTION

CAUTION indicates a hazardous situation which, if not avoided, **could result in** minor or moderate injury.

NOTICE

NOTICE is used to address practices not related to physical injury.

PLEASE NOTE

Electrical equipment should be installed, operated, serviced, and maintained only by qualified personnel. No responsibility is assumed by Schneider Electric for any consequences arising out of the use of this material.

A qualified person is one who has skills and knowledge related to the construction and operation of electrical equipment and its installation and has received safety training to recognize and avoid the hazards involved.

Table of contents

Chapter 1. SYSTEM ENVIRONMENT	8
1.1 Glossary	9
1.2 EcoStruxure EV Charging Expert.....	9
1.2.1 Overview	9
1.3 EcoStruxure EV Charging Expert characteristics	19
1.3.1 General characteristics	19
1.3.2 Environmental characteristics.....	19
1.3.3 Power supply characteristics	19
1.3.4 Communication modules	20
1.4 Set up of EcoStruxure EV Charging Expert system environment.....	21
1.4.1 EcoStruxure EV Charging Expert installation	21
1.5 Electrical zone definition	23
Chapter 2. EcoStruxure EV Charging Expert COMMISSIONING	26
2.1 Starting with EcoStruxure EV Charging Expert.....	26
2.1.1 Computer configuration	26
2.1.2 Login to the EcoStruxure EV Charging Expert	26
2.2 Credentials configuration	29
2.3 Wizard steps.....	29
2.3.1 Network.....	29
2.3.2 Remote supervision	29
2.3.3 Date & Time	29
2.3.4 Energy management	29
2.3.5 Stations configuration	30
2.3.6 Power meter configuration.....	30
2.3.7 Zones configuration	30
2.3.8 Station assignment	30
2.3.9 Authentication group.....	30
2.3.10 RFID Cards	30
Chapter 3. OPERATION INTERFACE	31
3.1 Menu and status bar	32
3.2 Dashboard.....	33
3.2.1 Global view	33
3.2.2 Zone view	34
3.2.3 Transaction view.....	35
3.2.4 Station view	35
3.3 Network configuration	37
3.3.1 EcoStruxure EV Charging Expert name	37
3.3.2 Network configuration	37
3.3.3 Proxy configuration	38
3.3.4 DHCP server configuration.....	38
3.4 Remote supervision configuration.....	39
3.4.1 Supervision selection.....	39
3.4.2 Unique supervision	39
3.4.3 Multiple supervision	40
3.5 Energy management configuration	42
3.5.1 Load shedding configuration	42
3.5.2 Consumption optimisation configuration.....	42
3.5.3 Allow Suspended by System	42

3.5.4	Local production management	43
3.6	Charging stations commissioning.....	45
3.6.1	Prerequisites	45
3.6.2	Charging station installation page.....	45
3.6.3	Charging station status	46
3.6.4	Charging station configuration	47
3.6.5	Manual charging station configuration	47
3.7	Power meter configuration	50
3.7.1	Prerequisites	50
3.7.2	Manage Power Meters.....	50
3.7.3	Define a new power meter model	51
3.8	Zone configuration.....	52
3.8.1	Prerequisites	52
3.8.2	Zone configuration	52
3.8.3	Zone creation	52
3.8.4	Degraded Mode	53
3.8.5	Charging station electrical zone assignation	53
3.9	Time Of Use	55
3.9.1	Definition	55
3.9.2	Prerequisites	55
3.9.3	Time Of Use configuration tab	55
3.9.4	Zone configuration tab	56
3.9.5	Summary tab.....	56
3.10	Digital Inputs.....	57
3.10.1	Definition	57
3.10.2	Commissioning	57
3.10.3	Electrical connection	58
3.11	Local authentication management	59
3.11.1	Authentication group	59
3.11.2	RFID cards.....	61
3.12	Certificates.....	62
3.12.1	Manage Certificates	62
3.12.2	Device certificates.....	63
3.13	Charging station firmware	64
3.13.1	Manage charging station firmware.....	64
3.13.2	Internal HTTP server.....	65
3.13.3	Perform charging station update.....	65
3.14	Advanced configuration.....	66
3.15	User management.....	67
3.15.1	User management landing page.....	67
3.15.2	User addition.....	67
3.15.3	Change the user password.....	68
3.15.4	Edit a user	68
3.16	Maintenance.....	69
3.16.1	Device logs	69
3.16.2	Device maintenance report.....	69
3.16.3	Charging station maintenance report.....	70
3.17	EV Charging Expert Firmware update	71
3.18	License upgrade	72
3.19	Reboot and back to factory settings	73
3.19.1	Reboot and back to factory settings from the webserver	73

3.19.2	Hardware back to factory settings	73
3.20	Save and Restore	75
3.20.1	Save configuration	75
3.20.2	Restore configuration.....	75
Chapter 4.	REGULATORY INFORMATION	77

Chapter 1.

SYSTEM ENVIRONMENT

1.1 Glossary

- **EV** : Electrical Vehicle
- **AC**: Alternate Current
- **DC**: Direct Current
- **VIP**: Very Important Person
- **RFID**: Radio Frequency Identification
- **CDR**: Charging Data Record
- **HMI**: Human Machine Interface
- **OCPP**: Open Charge Point Protocol
- **DHCP**: Dynamic Host Configuration Protocol

1.2 EcoStruxure EV Charging Expert

1.2.1 Overview

EcoStruxure EV Charging Expert (EVCE) is the necessary tool for optimizing the electricity usage associated with the Electrical Vehicle charging needs of a commercial building or a Multi Family Home.

EcoStruxure EV Charging Expert main features:

- Allocate a current setpoint to the charging stations in operation.
- See in real time the status of the charging stations through the dashboard.
- Manage user authentication for charging authorization.
- Get the charging sessions history and data from the charging stations in the network.
- Compatibility with remote supervision from a Charge Point Operator in OCPP 1.6 Json.
- EcoStruxure EV Charging Expert allows two access profiles:
 - **Admin**: Access to all configuration parameters and features, dashboard operation and RFID cards management.
 - **User**: Dashboard operation and RFID cards management.

1.2.1.1 Power management functions

For a specific electrical infrastructure, the maximum power available for EV charging is distributed among the connected vehicles.

An electric vehicle needs a minimum setpoint to accept charging and, if this minimum is not available, the charge will temporarily be suspended for this particular charging point.

The Load Management System allows the admin profile to choose between two thresholds (floor values) for AC charging:

- 8A by default for single phase charging and 14A by default for three-phase charging (based on EV/ZE ready)
- 6A by default for both single phase and three-phase (based on IEC 61851)

When a new vehicle connects and there is not enough available power, the system will suspend the charging of another vehicle to allow the new vehicle to charge.

Two options of charging prioritization are available during the configuration of the load management system:

- Energy:

The system suspends the charging of vehicles which have already consumed the highest amount of energy. This option is set by default.

- Duration:

The system suspends the charging of vehicles with the longest charging time.

In both cases, the EcoStruxure EV Charging Expert reviews these values every 15 minutes and updates charging priorities accordingly.

EcoStruxure EV Charging Expert can manage VIP information with admin profile:

- VIP RFID: Once authenticated as VIP EV driver, the EV gets maximum available* power no matter the charging station.
Note: VIP RFID card is not available when remote supervision communication is activated
- VIP charging station: The charging station allows any EV to get the maximum available* power.

**The maximum available power for VIP status may be lower than the charging station rating depending on the number of simultaneous VIP charging sessions.*

1.2.1.2 Static and dynamic power management

Static mode

The maximum current setpoint for the whole charging infrastructure is a static value depending on the subscribed power supply and limitations of power distribution. This current is distributed between all connected vehicles to limit the risk of installation tripping.

Consumption profile in static mode:

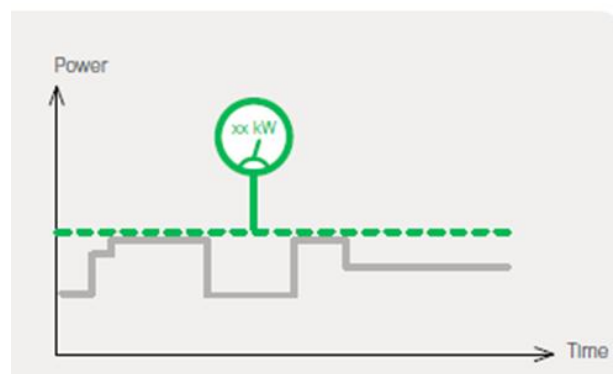

Dynamic mode

The maximum current setpoint for the whole charging infrastructure changes dynamically according to the building consumption while considering the subscribed power supply and/ or local production. The remaining available current is distributed between all connected vehicles to limit the risk of installation tripping.

Consumption profile in dynamic mode:

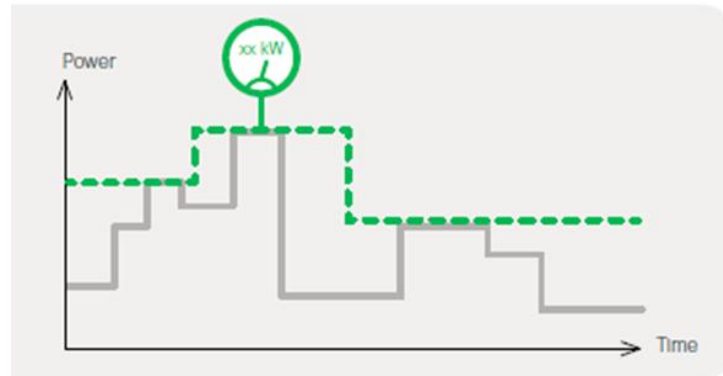

In dynamic mode, the EcoStruxure EV Charging Expert must be connected to power meters measuring the consumption of the building and the charging stations.

1.2.1.3 EcoStruxure EV Charging Expert product range & features

		Load Management License				
		HMIBSCEA53D1EDB	HMIBSCEA53D1EDS	HMIBSCEA53D1EDM	HMIBSCEA53D1EDL	HMIBSCEA53D1EM30
	Supported stations	EVlink Pro AC EVlink Pro DC Schneider Charge Pro	EVlink Pro AC EVlink Pro DC Schneider Charge Pro	EVlink Pro AC EVlink Pro DC Schneider Charge Pro	EVlink Pro AC EVlink Pro DC Schneider Charge Pro	Schneider Charge Pro
Capacity	Max number of charging stations	100	100	100	100	30
Power Management	With a static setpoint	●	●	●	●	●
	With a dynamic setpoint	●	●	●	●	●
Multi zone	Max number of zones	20	20	20	20	5
	Max number of zone levels (Top zone + sub-zones)	4	4	4	4	3
Advanced	Local production Local authentication Transactions logs	●	●	●	●	

		Load Management License	
		HMIBSCEA53D1EDBSCP	HMIBSCEA53D1EDSSCP
	Supported stations	EVlink Pro AC EVlink Pro DC Schneider Charge Pro	EVlink Pro AC EVlink Pro DC Schneider Charge Pro
Capacity	Max number of charging stations	100	100
Power Management	With a static setpoint	●	●
	With a dynamic setpoint	●	●
Multi zone	Max number of zones	20	20
	Max number of zone levels (Top zone + sub-zones)	4	4
Advanced	Local production Local authentication Transactions logs	●	●

1.2.1.4 User profile features

Operate EcoStruxure EV Charging Expert Dashboard

The dashboard displays:

- The status of all charge points (connectors)
- The power consumption per phase

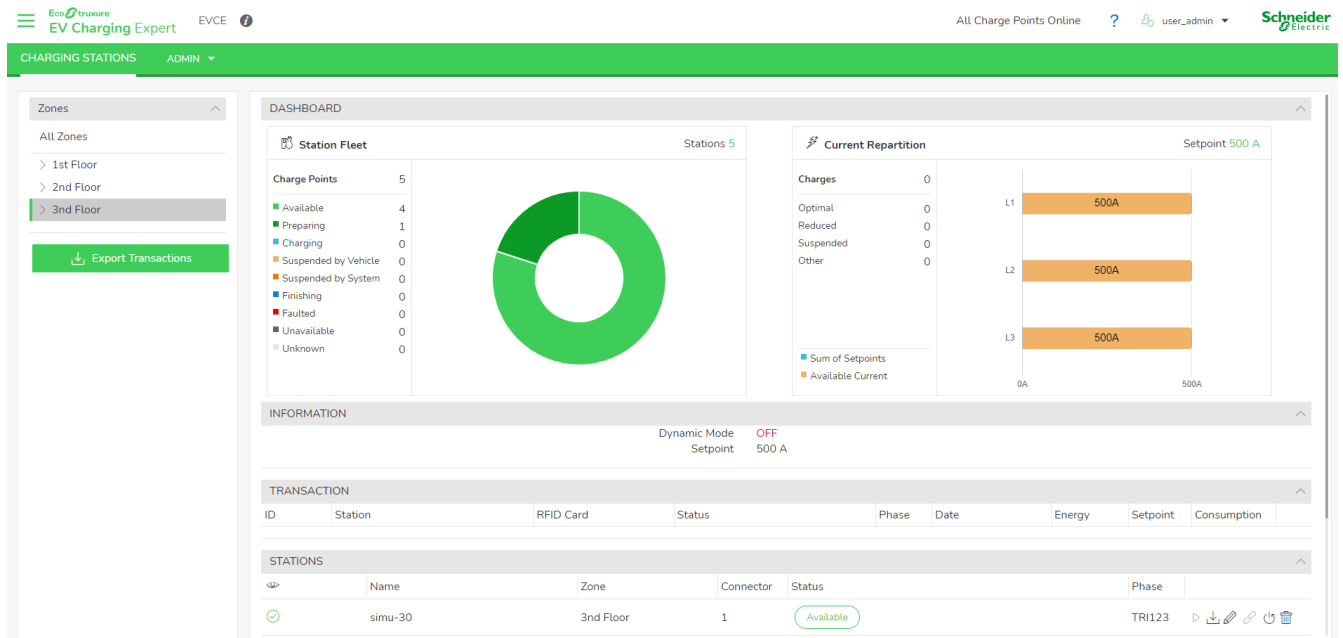

Remote control of charging station and transactions

Below actions are available through “Charging Station” tab:

- Remote start*
- Remote stop*
- Remote force stop*
- Reboot (automatic charging resume)
- Reset (charging stopped)
- Access to maintenance report
- Access to webserver (if feature available for charging station)

**Only available when remote supervision is deactivated*

RFID cards management

When the EcoStruxure EV Charging Expert is in standalone mode (remote supervision deactivated), it is possible to:

1. Create authentication group
2. Configure authentication strategy of each group
3. Allocate RFID cards and stations to these groups

Access through “RFID cards management” from the dashboard. See [chapter 3.11](#)

Export Charging Data Records (CDR)

On the EcoStruxure EV Charging Expert Dashboard, the user can see the active charging sessions.

EcoStruxure EV Charging Expert can register over 1 million transactions data, also called charging data records, in its internal memory. The charging data records can be exported as an external file in CSV format for all the charging stations.

It is possible to select the period before exporting the file.

Access through “Export transactions” from the dashboard. See [chapter 3.2.3](#)

1.2.1.5 Admin profile features

In addition to the user profile features, the admin profile can change the configuration of the charging stations, and upgrade EcoStruxure EV Charging Expert firmware.

EcoStruxure EV Charging Expert commissioning

All parameters are accessible via the admin/configuration page.

The admin profile sets configuration parameters for:

- Network configuration
- Remote supervision
- Energy management
- Date & Time
- Zone management
- Power meters
- Time of use
- Digital inputs
- Certificates
- Firmwares of charging stations
- Advanced Parameters
- User management
- Logs
- Device report
- Station reports
- Zone/Station configuration

EcoStruxure EV Charging Expert maintenance

The admin profile can:

- Update the EcoStruxure EV Charging Expert firmware
- Get EcoStruxure EV Charging Expert logs
- Operate a “Back to factory”
- Operate a “Save & restore”
- Manage users accounts and passwords
- Download EcoStruxure EV Charging Expert maintenance report
- Download charging station maintenance report
- Access the Wizard that is used for initial commissioning

1.2.1.6 EcoStruxure EV Charging Expert hardware features

Description

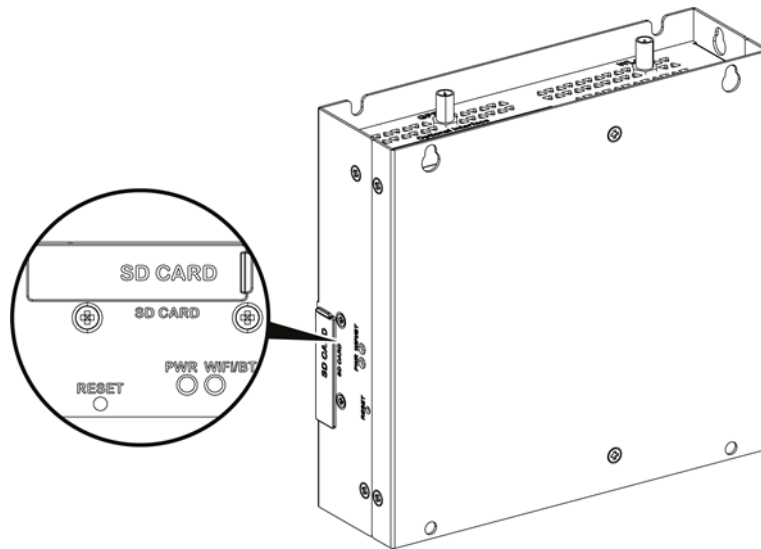

Reset button (deactivated) and LEDs

The table below describes the meaning of the status LEDs

Marking	Color	State	Meaning
PWR	Green	On	Active (user operates OS) (state S0)
WiFi/BT	Green	Off	Application failure
		On	Application starting
		Blink	Application running

Side view

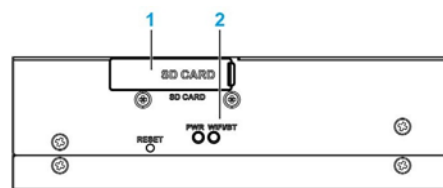

- 1 - SD card socket (SD card not delivered with the EcoStruxure EV Charging Expert)
- 2- LEDs

Front view

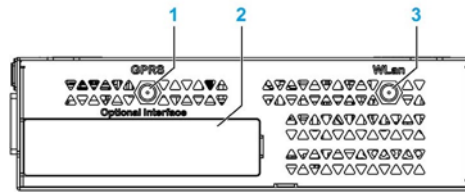

- 1 - SMA connector for the GPRS/4G external antenna (not available)
- 2 - Optional interface
- 3 - SMA connector for the WLAN external antenna (not available)

Rear view

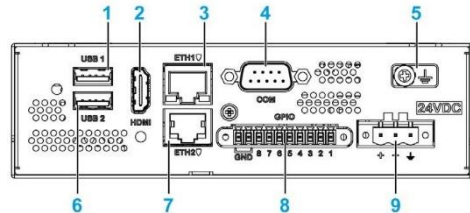

- 1 - USB1 (USB 2.0) (RTU ModBus device only)
 - 2 - HDMI port **(deactivated*)**
 - 3 - ETH1 (10/100/1000 Mb/s)
 - 4 - COM port RS-232/422/485 **(deactivated*)**
 - 5 - Ground connection pin
 - 6 - USB2 (USB 2.0) **(only for ModBus communication)**
 - 7 - ETH2 (10/100/1000 Mb/s) **(deactivated*)**
 - 8 - GPIO
 - 9 - DC power connector
- * **Hardware deactivation improves cybersecurity**

1.2.1.7 EVlink charging stations

Charging station	Supported	Minimal version
EVlink Pro AC	Yes	1.6.1
EVlink Pro DC 120/150/180	Yes	2.7.02
EVlink Pro DC 60	Yes	2.6.15
EVlink Parking	Yes	3.4.0.10
EVlink Smart WallBox	Yes	3.4.0.10
EVlink City	Yes	3.4.0.10
24kW DC Charger	Yes	V028.803
Schneider Charge Pro	Yes	2.0.3
Bender	No	
WallBee	No	





Latest releases are available on se.com/download.

For previous releases, contact [Schneider Electric Customer Care Center](#).

1.2.1.8 Power meters

Note: power metering is only required when the EcoStruxure EV Charging Expert is used in dynamic mode.

The table below lists few recommended power meters.

Name	Pole description	Input type	Comment
<p>A9MEM3250 (PAS600+ Acti 9 iEM3000)</p> 	<p>1P + N / 3P / 3P + N</p>	<p>External CT: 1 A or 5 A</p> <p>CT: Current Transformer</p>	
<p>METSEPM5320 (PowerLogic PM5000)</p> 	<p>1P + N / 3P / 3P + N</p>		
<p>A9XMWD20 (PowerTag Link + Power Tags)</p> 	<p>1P + N / 3P / 3P + N</p>	<p>Wireless energy sensor PowerTag up to 630 A</p>	
<p>Compact NSX circuit breaker with embedded metering (with Enerlin'X IFE gateway)</p> 	<p>3P / 4P</p>	<p>Modbus TCP</p>	<p>For 3P, If you want to have power per phase with NSX 3- poles, you must add external neutral voltage tap</p>
<p>Masterpact MTZ circuit breaker with embedded metering (with embedded Enerlin'X EIFE module)</p> 	<p>3P / 4P</p>	<p>Modbus TCP</p>	<p>For 3P, If you want to have power per phase with MTZ 3- poles, you must add external neutral voltage tap</p>

1.2.1.8.1 Modbus registers tables

The following tables show the ModBus registers per type of power meter.

Power meter model	“PM5320, IEM3x5x, Power tag A”
Register @	Description
3000	Current Ph1
3002	Current Ph2
3004	Current Ph3
3054	Power Ph1
3056	Power Ph2
3058	Power Ph3
3060	Total Active Power
3204	Total Active Energy Delivered

Power meter model	“NSX legacy”
Register @	Description
12016	Current Ph1
12017	Current Ph2
12018	Current Ph3
12038	Power Ph1
12039	Power Ph2
12040	Power Ph3
12041	Total Active Power
12050	Total Active Energy Delivered

Power meter model	“NSX”
Register @	Description
32028	Current Ph1
32030	Current Ph2
32032	Current Ph3
32077	Power Ph1
32074	Power Ph2
32076	Power Ph3
32078	Total Active Power
32096	Total Active Energy Delivered

Power meter model	“MTZ”
Register @	Description
32028	Current Ph1
32030	Current Ph2
32032	Current Ph3
32077	Power Ph1
32074	Power Ph2
32076	Power Ph3
32078	Total Active Power
32096	Total Active Energy Delivered

Other power meters that are not part of this selection (refer to [chapter 1.1.1.8](#)) are compatible with EcoStruxure EV Charging Expert as well. When commissioning the power meter, select from the drop-down list on “Model” field the corresponding model of power meter matching the appropriate registers list.

See [chapter 3.6](#) for more information.

1.3 EcoStruxure EV Charging Expert characteristics

1.3.1 General characteristics

Element	Characteristics
Operating System	Linux Yocto
Cooling method	Natural air flow
Weight	1 kg (2.2 lbs)

1.3.1.1 Dimensions

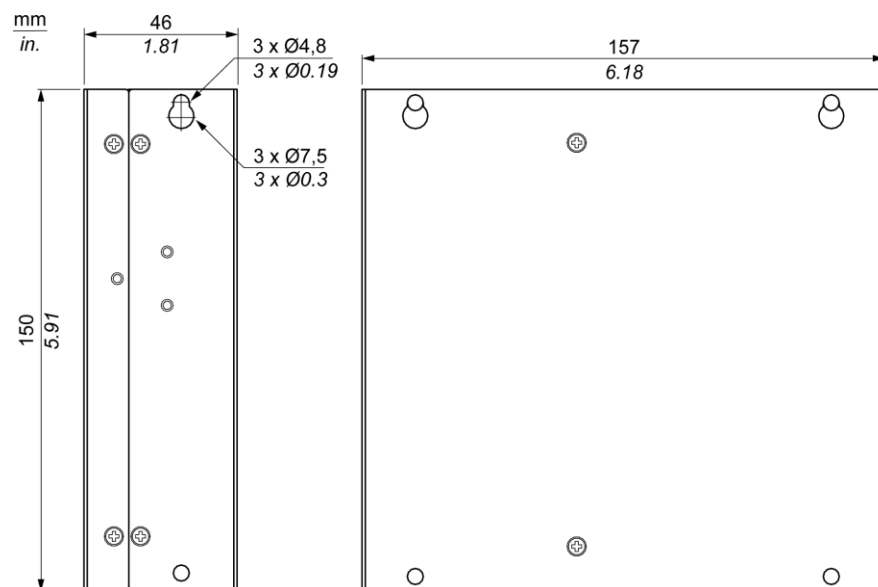

1.3.2 Environmental characteristics

Characteristics	Value
Degree of protection	IP 40
Pollution degree	For use in pollution degree 2 environment
Operating temperature	0...50 °C
Operating temperature for horizontal mounting	0...50 °C
Storage temperature	0...50 °C
Operating altitude	2,000 m (6,560 ft) max
Random vibration	5...500 Hz: 2 G _{rms}
Storage humidity	10...95 % RH at 40 °C (104 °F), no condensation

1.3.3 Power supply characteristics

Element	Characteristics
Rated voltage	24 Vdc
Inrush current	1,5 A
Power consumption	16 W

1.3.4 Communication modules

1.3.4.1 USB interface

Element	Characteristics
Type	USB 2.0
Current load	Maximum 0.5 A
Connection	Type A

1.3.4.2 Ethernet interface

Element	Characteristics
Type	RJ45
Speed	10/100/1000 Mb/s base-T

1.4 Set up of EcoStruxure EV Charging Expert system environment

1.4.1 EcoStruxure EV Charging Expert installation

See DOCA0164EN EcoStruxure EV Charging Expert installation guide” available on the EcoStruxure EV Charging Expert packaging and on se.com/download.

1.4.1.1 Ethernet connection: charging station connection

EcoStruxure EV Charging Expert is connected to the charging station network through ethernet ETH1.

Use an ethernet straight cable between EcoStruxure EV Charging Expert and the charging station Ethernet network.

NOTICE

IMPOSSIBLE TO COMMISSION A CHARGING STATION INTO ECOSTRUXURE EV CHARGING EXPERT

- Connect the charging station network only ETH 1
- ETH 2 network must be activated through UI (see 3.3 Network Configuration)

Failure to follow this instruction will not enable EcoStruxure EV Charging Expert connectivity and expected functionalities.

1.4.1.2 Power meter connection

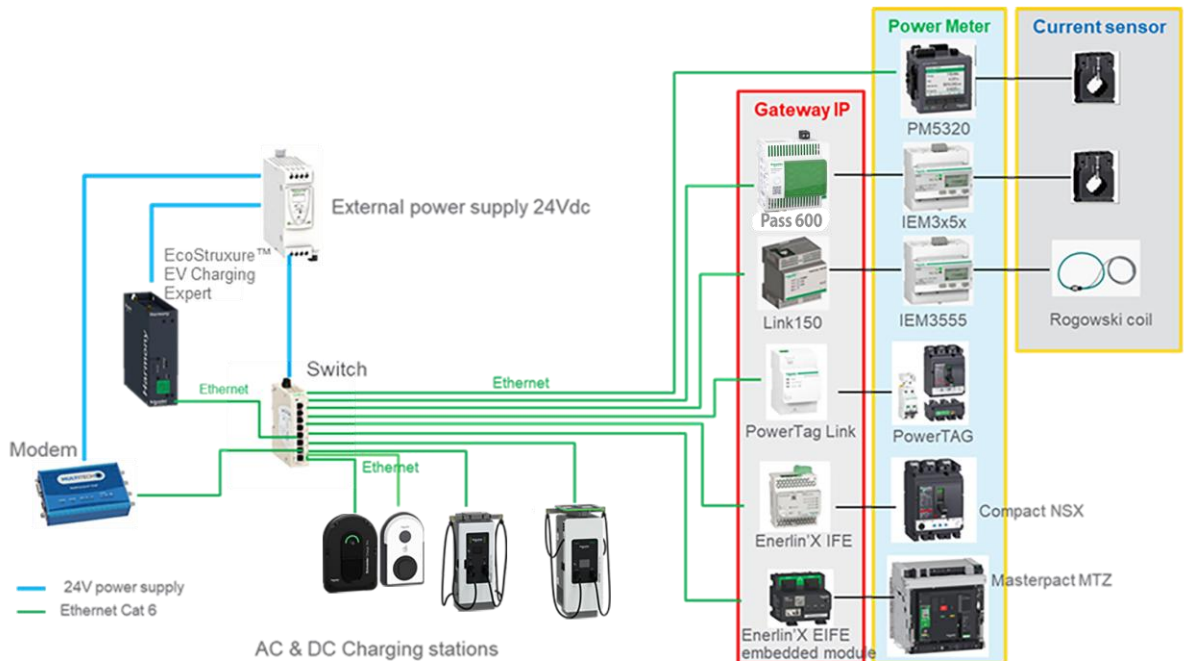

Gateways and power meters must be set correctly before starting the EcoStruxure EV Charging Expert commissioning. Please check the relevant documentation to perform this step.

Note: power metering is only required when the EcoStruxure EV Charging Expert is used in dynamic load management mode.

1.4.1.3 Connection to EMA

EVCE can be connected to EMA using the REST API (see related documents) and the user "EBMS".

 CAUTION
--

It's not possible to be logged in same time by the web interface and by the REST API.
--

1.4.1.4 Connection to EBO (EcoStruxure Building Operation)

EVCE can be connected to EBO with an EBO plugin called "EVCE SmartConnector". Please contact the EBO support for more information.

1.5 Electrical zone definition

An electrical zone is made of one switchboard:

- directly supplying charging stations and possibly other electrical loads,
- or supplying other switchboards of which at least one is supplying charging stations and possibly other electrical loads. This latter forms a sub-zone. The total installed current of all sub-zones must be at least equal to the maximum current that can be delivered by the upper zone switchboard. A maximum of three levels of sub-zones is possible.

For a dynamic zone, a maximum degraded current should be defined in case of power meter disconnection. This maximum degraded current corresponds to the among of available current that is always guaranteed for EV charging.

Example #1: one single zone

In this example, the main switchboard can supply both switchboards at the maximum current. Energy management is required in the zone if the switchboard #1 cannot supply all charging stations and other electrical loads at the same time at the maximum current.

In case of a power meter disconnection, if the maximal building electrical load of the zone is estimated to ~150A, the maximal available current for EV charging in this zone is 100A.

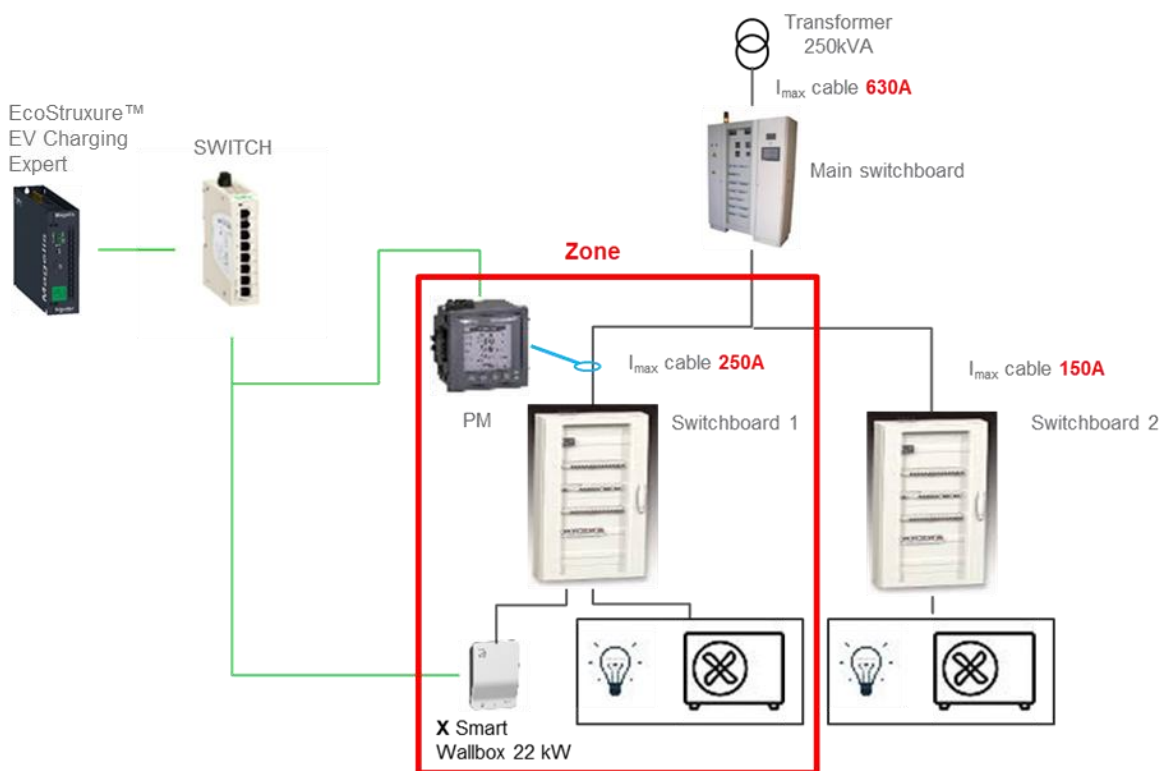

Example #2: one zone with one sub-zone

In this example, the main switchboard cannot supply both switchboards at the maximum current. In the same way, the switchboard #1 cannot supply all charging stations and other electrical loads at the same time at the maximum current.

The current available for EV charging depends on:

- the total consumption of other electrical loads supplied by switchboards #1 and #2 due to the current limitation of the main switchboard (630 A),
- the consumption of other electrical loads supplied by switchboard #1 due to its current limitation (400 A)

In case of power meter disconnection, the maximum degraded current of the top zone should be defined regarding the estimation of the maximum building electrical loads of switchboards #1 and #2.

As a result, it is necessary to define a zone (main switchboard) with a sub-zone (switchboard #1).

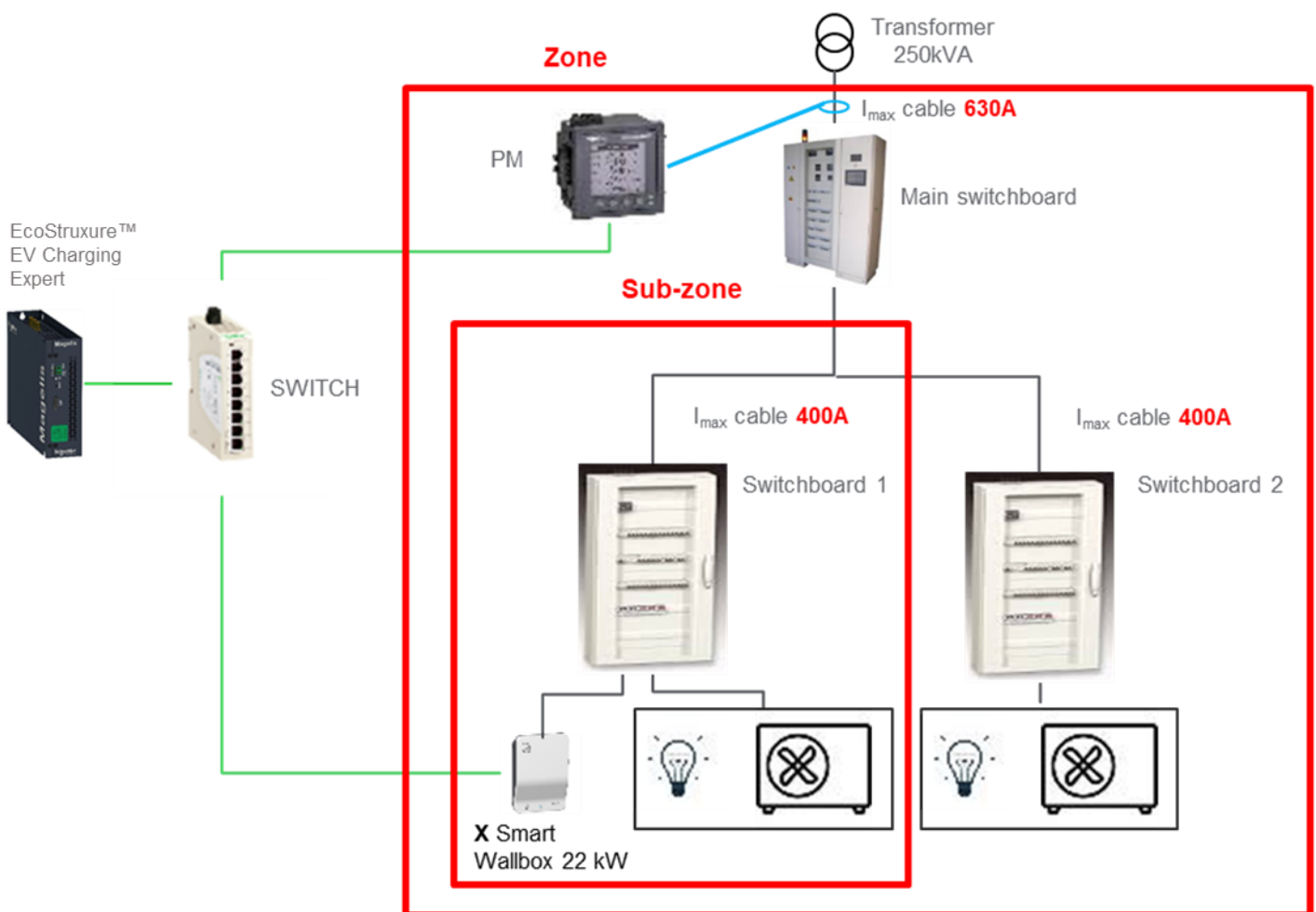

Example #3: two zones at the same level

In this example, the main switchboard can supply switchboards #1 & #2 at the maximum power. Energy management is required in each zone if switchboards #1 and #2 cannot supply all charging stations and other electrical loads at the same time at the maximum power.

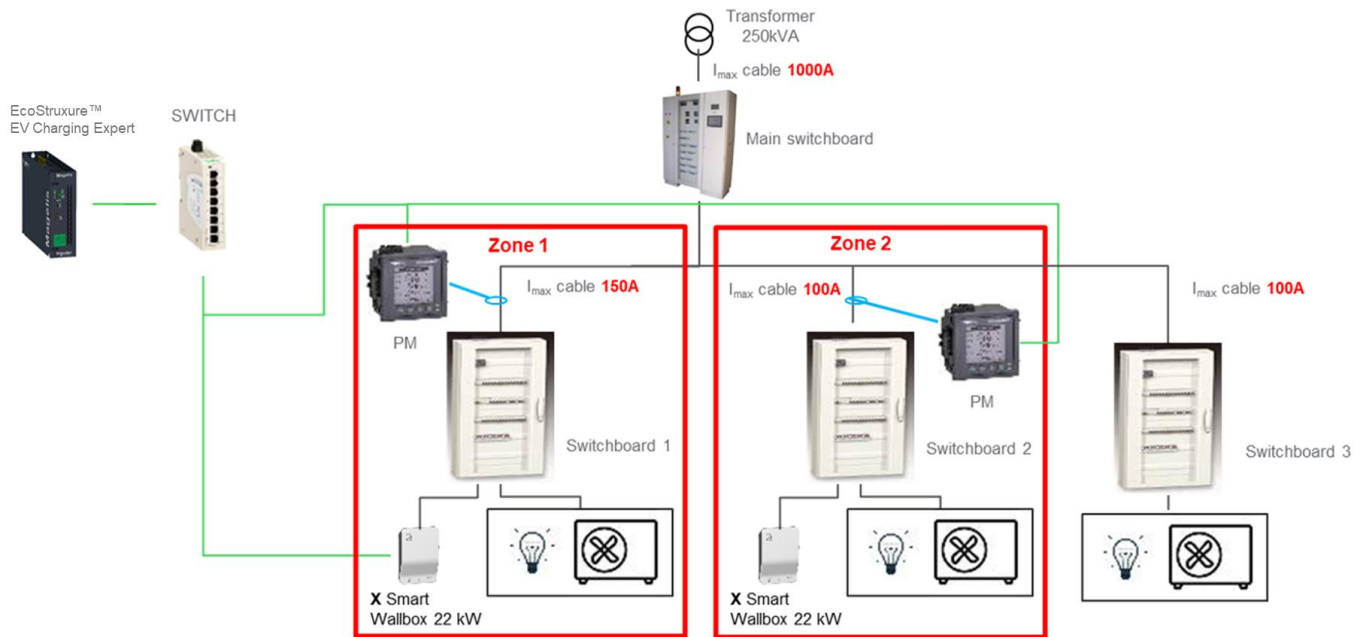

Chapter 2.

EcoStruxure EV Charging Expert

COMMISSIONNING

During the first commissioning, a configuration assistant (**wizard**) will guide the installer to set the EcoStruxure EV Charging Expert. If you have already done the first commissioning, please go to [chapter 3 OPERATION INTERFACE](#).

NOTICE

IMPOSSIBLE TO COMMISSION IN ECOSTRUXURE EV CHARGING EXPERT A CHARGER WITH ONGOING CHARGING SESSION.

- Stop all ongoing charging session
- Unplug all cars connected to the charging station
- Start the EcoStruxure EV Charging Expert commissioning or re-commissioning

Failure to follow these instructions can block the stations pairing with EV Charging Expert.





2.1 Starting with EcoStruxure EV Charging Expert

2.1.1 Computer configuration

Step	Action
1	Connect your computer to the EcoStruxure EV Charging Expert Ethernet network
2	Open the local network properties menu on your computer
3	Open Internet Protocol TCP/IP v4 properties.
4	Set the static IP address properties as follows: IP address: 192.168.0.x (where x is a number between 50 and 100) Subnet mask: 255.255.255.0 No default gateway No DNS server No proxy

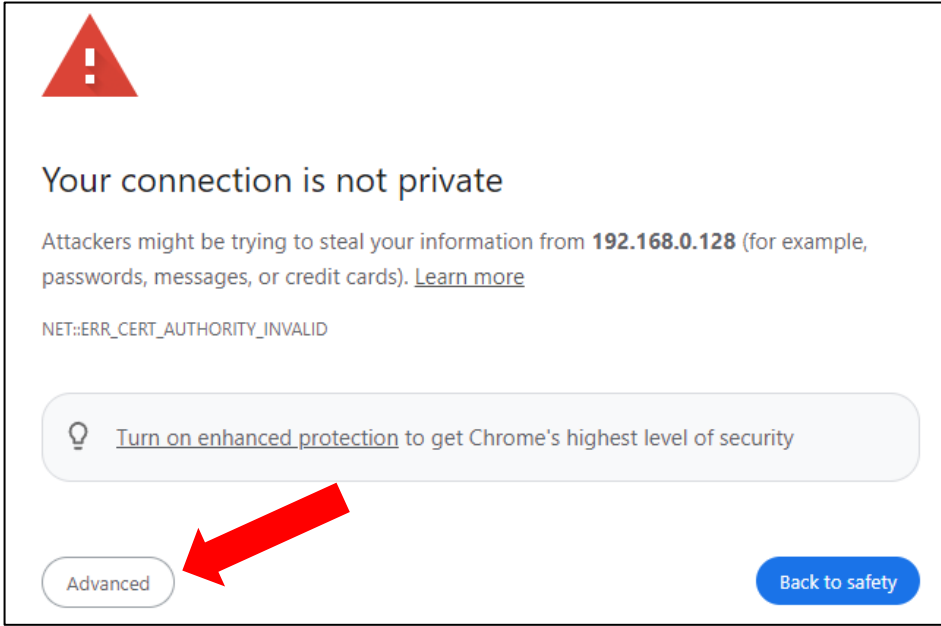
2.1.2 Login to the EcoStruxure EV Charging Expert

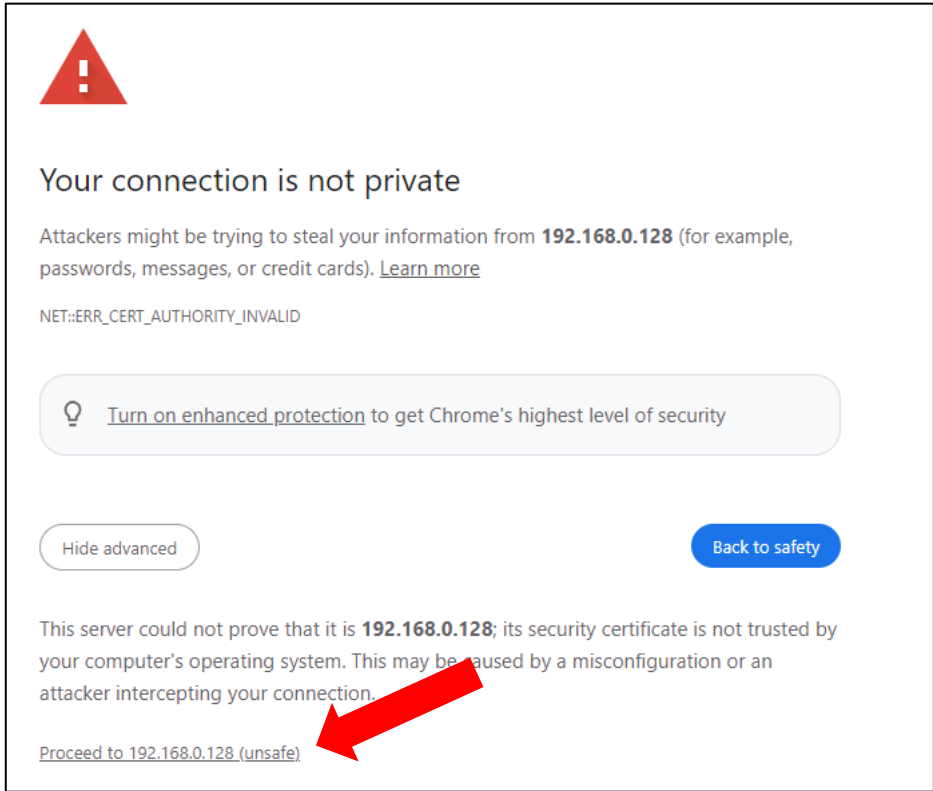
Step	Action
1	Open a web browser and type 192.168.0.128 in the URL field

Step	Action
	<p data-bbox="375 203 1431 235">A security warning may be displayed: click on "Advanced" button if this occurs (see capture below)</p> <div data-bbox="430 264 1375 887" style="border: 1px solid black; padding: 10px;">  <p data-bbox="470 280 566 369"></p> <h3 data-bbox="470 425 933 459">Your connection is not private</h3> <p data-bbox="470 492 1300 555">Attackers might be trying to steal your information from 192.168.0.128 (for example, passwords, messages, or credit cards). Learn more</p> <p data-bbox="470 577 758 604">NET::ERR_CERT_AUTHORITY_INVALID</p> <div data-bbox="470 660 1348 739" style="border: 1px solid #ccc; border-radius: 10px; padding: 5px; margin: 10px 0;">  Turn on enhanced protection to get Chrome's highest level of security </div> <div data-bbox="470 817 598 862" style="border: 1px solid #ccc; border-radius: 15px; padding: 5px 15px; display: inline-block;">Advanced</div> <div data-bbox="1189 817 1348 862" style="border: 1px solid #0070c0; border-radius: 15px; padding: 5px 15px; display: inline-block; background-color: #0070c0; color: white;">Back to safety</div> </div> <p data-bbox="742 963 1093 996" style="text-align: center;">Then click on "Proceed to @ ..."</p> <div data-bbox="438 1012 1375 1800" style="border: 1px solid black; padding: 10px;">  <p data-bbox="470 1041 566 1131"></p> <h3 data-bbox="470 1176 901 1209">Your connection is not private</h3> <p data-bbox="470 1232 1236 1294">Attackers might be trying to steal your information from 192.168.0.128 (for example, passwords, messages, or credit cards). Learn more</p> <p data-bbox="470 1317 742 1344">NET::ERR_CERT_AUTHORITY_INVALID</p> <div data-bbox="470 1388 1276 1467" style="border: 1px solid #ccc; border-radius: 10px; padding: 5px; margin: 10px 0;">  Turn on enhanced protection to get Chrome's highest level of security </div> <div data-bbox="470 1534 630 1579" style="border: 1px solid #ccc; border-radius: 15px; padding: 5px 15px; display: inline-block;">Hide advanced</div> <div data-bbox="1125 1534 1284 1579" style="border: 1px solid #0070c0; border-radius: 15px; padding: 5px 15px; display: inline-block; background-color: #0070c0; color: white;">Back to safety</div> <p data-bbox="470 1624 1284 1720">This server could not prove that it is 192.168.0.128; its security certificate is not trusted by your computer's operating system. This may be caused by a misconfiguration or an attacker intercepting your connection.</p> <p data-bbox="470 1747 742 1774">Proceed to 192.168.0.128 (unsafe)</p> </div>

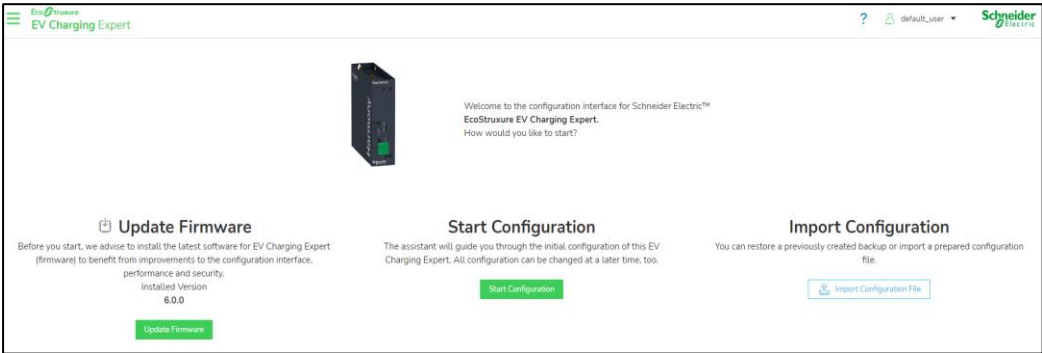
Step	Action
2	<p data-bbox="379 197 1091 226">To start with EcoStruxure EV Charging Expert, there are 3 options:</p> <div data-bbox="379 259 1426 611"><p>The screenshot displays the 'EcoStruxure EV Charging Expert' configuration interface. At the top, there is a navigation bar with the product name and a user profile. The main content area features a central image of the device and a welcome message: 'Welcome to the configuration interface for Schneider Electric™ EcoStruxure EV Charging Expert. How would you like to start?'. Below this, three options are presented: 'Update Firmware' (with a note about installing the latest software for performance and security, version 6.0.0), 'Start Configuration' (with a note about the assistant guiding through initial configuration), and 'Import Configuration' (with a note about restoring a backup or importing a file). Each option has a corresponding button.</p></div> <ul data-bbox="427 667 1437 853" style="list-style-type: none">• Update the firmware: It is recommended to update the product with the latest version of firmware that has been issued. The file needs to be available locally, hence the installer needs to download it previously from se.com.• Start new configuration : chapter 2.3• Import EcoStruxure EV Charging Expert: chapter 3.20.2

2.2 Credentials configuration

In EcoStruxure EV Charging Expert there are two different user profiles:

- **Administrator:** Access to all configuration parameters and features, dashboard operation and RFID card management.
- **Operator:** Dashboard operation and RFID card management.

The screenshot shows the 'Set Login Credentials' page in the EcoStruxure EV Charging Expert interface. The page is divided into two main sections: 'Administrator' and 'First User'. The 'Administrator' section includes a warning about unauthorized access, a description of the administrator role, and three input fields: 'Username', 'Password', and 'Repeat Password'. The 'Password' field has a tooltip indicating that passwords must be at least 12 characters long, include lowercase, uppercase, numbers, and special characters. Below the 'Repeat Password' field is a checkbox for 'I securely stored these credentials'. The 'First User' section includes a description of the first user role and a checkbox for 'I securely stored these credentials'. The page has a 'Previous' button on the left and a 'Save and Next' button on the right.

At the credentials step, the installer is asked to create an administrator profile and a user profile.

The passwords must satisfy the following conditions:

- at least 12 characters long lowercase
- characters uppercase
- characters numbers
- special characters (@!%?&).

The login cannot be “Root”, “Admin” or “Administrator”.

2.3 Wizard steps

The wizard allows to configure EcoStruxure EV Charging Expert with only 10 steps.

2.3.1 Network

See [chapter 3.3](#)

2.3.2 Remote supervision

See [chapter 3.4](#)

2.3.3 Date & Time

2.3.4 Energy management

See [chapter 3.5](#)

2.3.5 Stations configuration

See [chapter 3.6](#)

2.3.6 Power meter configuration

See [chapter 3.7](#)

2.3.7 Zones configuration

See [chapter 3.8](#)

2.3.8 Station assignment

See [chapter 3.8.5](#)

2.3.9 Authentication group

See [chapter 3.11.1](#)

2.3.10 RFID Cards

See [chapter 3.11.2](#)

Chapter 3.

OPERATION INTERFACE

3.1 Menu and status bar

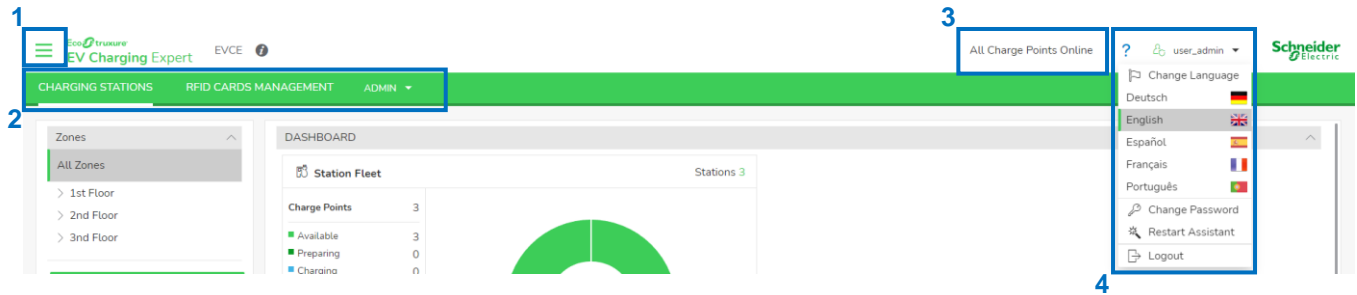

Mark	Description
1	Menu to update EcoStruxure EV Charging Expert and upgrade licence
2	Administrator menu to manage configurations
3	Charging station status (Online/Offline/Faulted state)
4	User management: <ul style="list-style-type: none"> • Change language • Update password • Restart assistant: restart wizard menu • Logout

3.2 Dashboard

3.2.1 Global view

This page displays the ongoing status of the charging stations, load transaction information and zone configuration. Furthermore, it's possible to manage charging stations (reboot/remote start&stop/diagnostic report).

The screenshot displays the 'EV Charging Expert' dashboard. The interface is divided into four main sections, numbered 1 through 4:

- 1. Zones:** A sidebar menu on the left showing a hierarchical view of zones: 'All Zones', '1st Floor' (with sub-items '1st Floor - South' and '1st Floor - North'), '2nd Floor', and '3rd Floor'. An 'Export Transactions' button is located at the bottom of this sidebar.
- 2. DASHBOARD:** The main content area at the top right, titled 'Station Fleet' with 'Stations 3'. It features a donut chart showing the status of 3 charge points: Available (2), Preparing (0), Charging (1), Suspended by Vehicle (0), Suspended by System (0), Finishing (0), Faulted (0), Unavailable (0), and Unknown (0).
- 3. TRANSACTION:** A table below the dashboard showing a single transaction record:

ID	Station	RFID Card	Status	Phase	Date/Duration	Energy	Setpoint	Consumption
1	A11223344001	SIMTAG	Charging	1 2 3	15/07/2024, 09:34:57 1 minute	0.33 kWh	32 A	31.93 A
- 4. STATIONS:** A table at the bottom showing station assignment:

Name	Zone	Connector	Status	Phase
A11223344001	1st Floor - South	1	Charging	TRI123

The global view is made of four parts:

1. Electrical zone topology and transactions exports information.
2. Dashboard with zones and charging stations information.
3. Transaction information and management.
4. Stations assignation and management.

3.2.2 Zone view

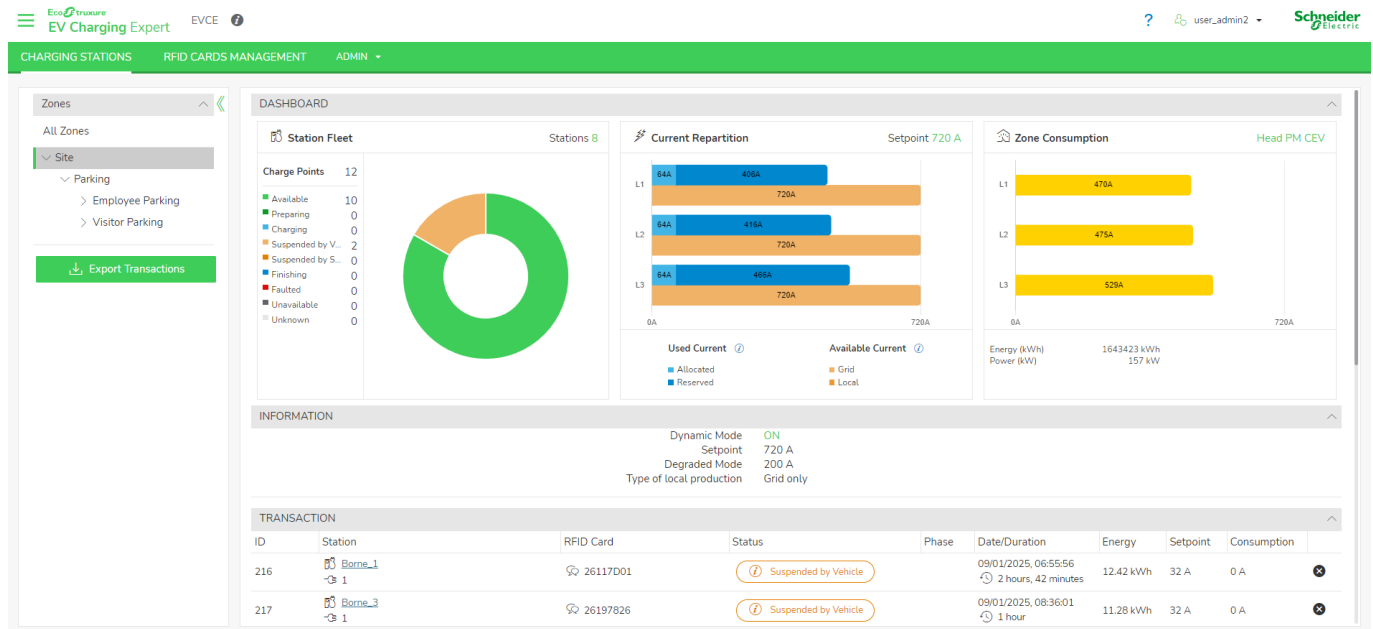

Zone view is available when a zone is selected in the zone topology panel. The zone view provides below data:

- **Station Fleet:** Status of charging stations assigned to the zone.
- **Current Repartition:** Charging setpoint available according to the active zone maximum current, zone consumption and transactions information.
 - **Allocated:** Allocated current to charging stations during transaction
 - **Reserved:** Reserved current for building consumptions and disconnected stations (degraded setpoint apply to charging station).
 - **Grid:** Available current from grid (with reduction)
 - **Local:** Available current from local production
- **Zone Consumption** (only for dynamic zone): Consumption of the zone reported by assigned power meter.

Name	Zone	Connector	Status	Phase
A11223344001	1st Floor - South	1	Charging	TR1123

Zone view is enabling charging stations management:

- **Remote start** ▶: Start a charging session (deactivated when supervision is configured).
- **Diagnostic** ↓: Generate a manual charging station report of the charging station ([see chapter 3.16.3](#) for download page).
- **Configuration** ✎: Update charging station configuration (see [chapter 3.2.4](#)).
- **Webserver** 🌐: Webserver of the charging station (option available only for charging station supporting web pages interface).
- **Reboot** 🔄
- **Delete** 🗑️: Delete charging station configuration into EcoStuxure EV Charging Expert (impossible to delete a charging station with an ongoing transaction).

3.2.3 Transaction view

The screenshot displays the 'Transaction view' in the EcoStruxure EV Charging Expert interface. The top navigation bar includes 'CHARGING STATIONS', 'RFID CARDS MANAGEMENT', and 'ADMIN'. The left sidebar shows 'Zones' with a tree view including 'Site', 'Parking', 'Employee Parking', and 'Visitor Parking'. A green 'Export Transactions' button is highlighted in the sidebar. The main content area is divided into three panels: 'Station Fleet' with a donut chart showing 12 charge points (10 Available, 2 Suspended by V...), 'Current Repartition' with a bar chart showing current usage for L1, L2, and L3 phases, and 'Zone Consumption' with a bar chart showing energy and power consumption for L1, L2, and L3. Below these panels is an 'INFORMATION' section with system parameters like Dynamic Mode (ON), Setpoint (720 A), and Degraded Mode (200 A). At the bottom, a 'TRANSACTION' table shows a single entry for ID 216, Station Borne_1, RFID Card 26117001, Status Suspended by System, Date/Duration 09/01/2025, 06:55:56 (2 hours, 42 minutes), Energy 12.42 kWh, Setpoint 0 A, and Consumption 0 A. A 'Do you want to stop the transaction?' dialog is visible with a 'Force Remote Stop' checkbox and 'Confirm'/'Cancel' buttons.

Transaction view provides all information for an active transaction:

- **ID:** Unique identifier of the transaction
- **Station:** Station name and connector used for the charging session
- **RFID Card:** Card which launch the transaction.
- **Status:** Status of the transaction according to OCPP standard (Charging / SuspendedEV / SuspendedEVSE / Finishing)
- **Phase:** Selected phases by EV (mono-phase or tri-phased)
- **Date/Duration:** Transaction start date and effective charging duration (time passed in charging state)
- **Energy:** Energy consumed by the ongoing transaction
- **Setpoint:** Current setpoint (intensity or power allocated to the charging station).
- **Consumption:** Consumption of the charging station.

At the left of ongoing charging session, it's possible to remotely stop the charging sessions with the button , a **Force Remote Stop** option is available to stop a charging session if there are some troubles with this charging session.

Transaction logs are available for download by using **Export Transactions** button. Select a start and end date to make a partial transaction export.

3.2.4 Station view

The screenshot displays the 'Station view' in the EcoStruxure EV Charging Expert interface. The top navigation bar includes 'CHARGING STATIONS', 'RFID CARDS MANAGEMENT', and 'ADMIN'. The left sidebar shows 'Zones' with a tree view including '1st Floor', '2nd Floor', and '3rd Floor'. A green 'Export Transactions' button is highlighted in the sidebar. The main content area shows configuration details for station A11223344001. Fields include Name (A11223344001), Charge Box Identity (A11223344001), VIP (checkbox), Phase Configuration (TRI123), Vendor (Schneider ElectricEVlink Pro AC), Firmware (1.3.8), and Degraded Mode (Connector 1: 32 A). 'Update' and 'Cancel' buttons are at the bottom right.

To access the station details, select the charging station in zones hierarchy. Below information is accessible:

- **Name:** Name of the charging station into EcoStruxure EV Charging Expert.
- **Charge Box Identity:** Name of the charging station for the remote supervision.
- **VIP:** Select this option to activate VIP for the charging station.
- **Phase configuration:** Electrical configuration of charging station (see [chapter 3.5.4](#))
- **Vendor:** Vendor of the charging station.
- **Firmware:** Firmware version and management (see [chapter 3.13](#)).
- **Degraded Mode:** Current allocated to the charging station in degraded mode (see [chapter 3.7.4](#)).

The screenshot displays the EcoStruxure EV Charging Expert interface. The top navigation bar includes 'CHARGING STATIONS', 'RFID CARDS MANAGEMENT', and 'ADMIN'. The left sidebar shows a 'Zones' hierarchy with '1st Floor' expanded, listing three devices: A11223344001, A11223344002, and A11223344003. The main content area shows a confirmation dialog 'Do you want to stop the transaction?' with a 'Force Remote Stop' checkbox and 'Confirm'/'Cancel' buttons. Below this is the 'LOGS' section for device 'A11223344001', featuring a search filter, 'Download Logs', and 'Refresh' buttons. The log table contains the following data:

Date	Device	Type	Sub Type	Message
15/07/2024, 16:41:52	A11223344001	OCPP	StatusNotification	Connector = 1 - Status = Charging - Error = NoError
15/07/2024, 16:41:51	A11223344001	OCPP	StatusNotification	Connector = 1 - Status = SuspendedEVSE - Error = NoError
15/07/2024, 16:41:33	A11223344001	OCPP	StatusNotification	Connector = 1 - Status = Charging - Error = NoError
15/07/2024, 16:41:31	A11223344001	OCPP	StatusNotification	Connector = 1 - Status = SuspendedEVSE - Error = NoError
15/07/2024, 16:41:13	A11223344001	OCPP	StatusNotification	Connector = 1 - Status = Charging - Error = NoError
15/07/2024, 16:41:11	A11223344001	OCPP	StatusNotification	Connector = 1 - Status = SuspendedEVSE - Error = NoError
15/07/2024, 16:40:53	A11223344001	OCPP	StatusNotification	Connector = 1 - Status = Charging - Error = NoError
15/07/2024, 16:40:51	A11223344001	OCPP	StatusNotification	Connector = 1 - Status = SuspendedEVSE - Error = NoError

In station view, a log section displays all OCPP commands received by EcoStruxure EV Charging Expert from the selected charging station.

3.3 Network configuration

Access by the Admin tab → Configuration → Network

Réseau

Nom de l'appareil

Configuration du proxy OFF ON

URL du proxy

EV Network ⓘ

Activer DHCP client OFF ON

Adresse IP

Masque de sous réseau

Passerelle par défaut

DNS Server

Serveur DNS préféré

Serveur DNS auxiliaire

Configuration du serveur DHCP ⓘ OFF ON

Plage d'adresse

3.3.1 EcoStruxure EV Charging Expert name

It is mandatory to define a name to EcoStruxure EV Charging Expert.

3.3.2 Network configuration

EV Network ⓘ

Activer DHCP client OFF ON

Adresse IP

Masque de sous réseau

Passerelle par défaut

Secondary Network ⓘ OFF ON

Activer DHCP client OFF ON ⓘ

Adresse IP

Masque de sous réseau

Passerelle par défaut

Fields	Factory setting	Description
EV network		
Activate DHCP client	Activated	Activate or not the DHCP client. The device IP address will change based on the DHCP if you activate this.
IP address	192.168.0.128	EcoStruxure EV Charging Expert IP address
Network mask	255.255.255.0	EcoStruxure EV Charging Expert sub-network mask
Default gateway (1)	192.168.0.254	Gateway IP address. Mandatory to connect two networks so that devices on one network can communicate with the devices of another network.
Preferred DNS server (2)	8.8.8.8	Preferred DNS server IP address (2)
Alternative DNS server	-	Other DNS server IP address (2)
Secondary Network		
	Deactivated	Activate another subnetwork on the second ethernet port to access the web pages

- (1) Address of the modem used for the connection to the supervision, if any. All charging stations on the same sub-network than EVCE must be configured with the same gateway IP address.
- (2) DNS Server is used to convert URL to IP address. May be provided by the remote supervision (through a dedicated SIM card for example). Google DNS server by default.

NOTICE**PRESENCE OF CHARGING STATIONS IN A DIFFERENT SUBNETWORK OF ECOSTRUXURE EV CHARGING EXPERT**

Configure for each charging station gateway and DNS information

Failure to follow these instructions can result in a network issue for all connected devices.

3.3.3 Proxy configuration

Proxy URL: Proxy URL when proxy is used as an intermediary between a user's device and the internet, enhancing security by masking the user's IP address, allowing organizations to control and monitor internet usage, and enabling access to geo-blocked or restricted content.

3.3.4 DHCP server configuration

DHCP: Dynamic Host Configuration Protocol is a protocol used to provide quick, automatic, and central management for the distribution of IP addresses within a network.

EcoStruxure EV Charging Expert can be configured to act as a DHCP server to assign IP addresses to charging stations in the defined range.

by-default sub-network (192.168.0.0-255) is being used. The use of 192.168.0.0, 192.168.0.254 and 192.168.0.255 are to avoid.

NOTICE**PRESENCE OF A DHCP SERVER ON THE NETWORK WHICH CONFLICTS WITH ECOSTRUXURE EV CHARGING EXPERT DHCP SERVER.**

Deactivate EcoStruxure EV Charging Expert DHCP server

Failure to follow these instructions can result in a network issue for all connected devices.

3.4 Remote supervision configuration

Access by the Admin tab → configuration → remote supervision

3.4.1 Supervision selection

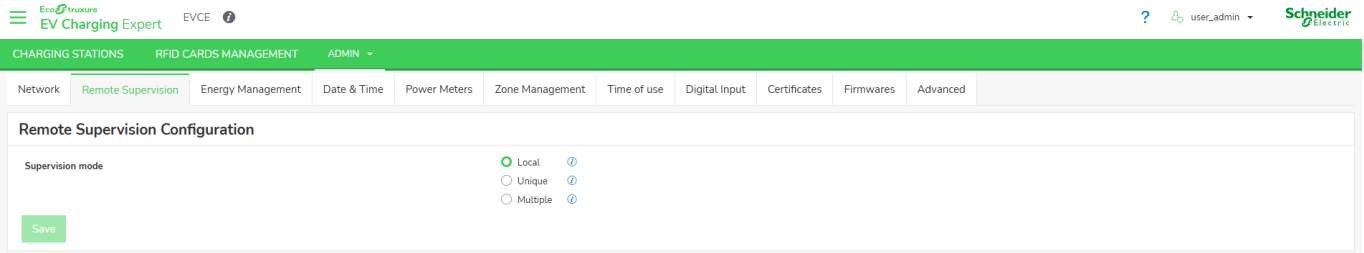

There are 3 types of EcoStruxure EV Charging Expert supervision:

- **Local:** EcoStruxure EV Charging Expert is managing authentication rules and badges. See [chapter 3.11](#)
- **Unique:** One supervision is managing authentication rules and badges of the complete installation
- **Multiple:** Charging stations are divided in groups managed by a specific supervision or by EcoStruxure EV Charging Expert

3.4.2 Unique supervision

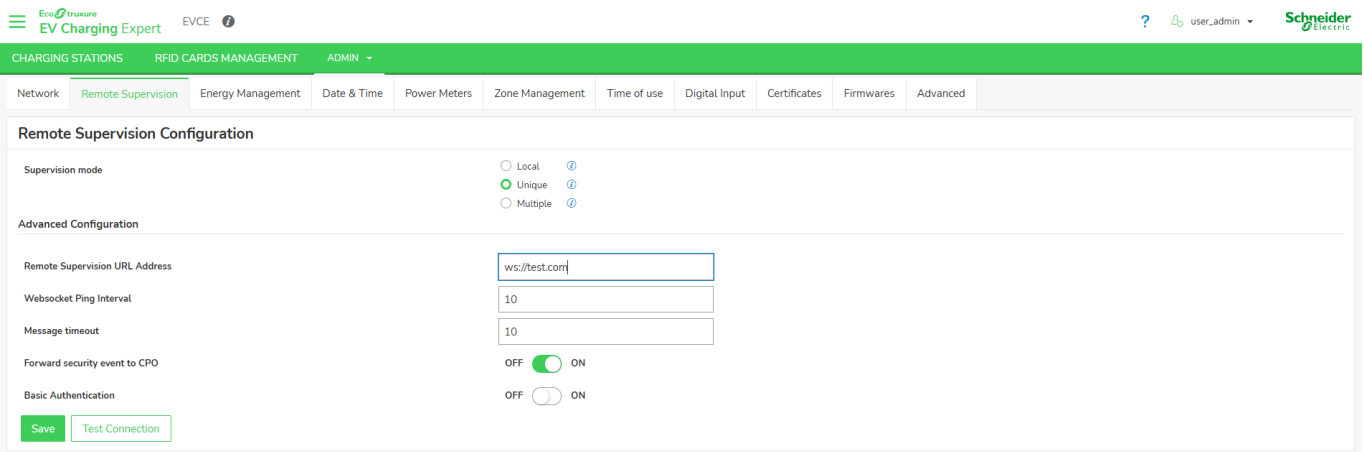

3.4.2.1 Prerequisites

Remote supervision must be enabled to allow its configuration. Enter the URL to be used by the charging stations to establish communication with the remote supervision. The communication protocol **must be OCPP 1.6 Json**.

3.4.2.2 Supervision configuration

- **URL Address:** Enter WebSocket (ws) or WebSocket Secure (wss) URL. It is recommended to use a WebSocket secure as a good practice of cybersecurity. In this case, it is necessary to add a certificate after commissioning steps, see [chapter 3.12](#).
- **Websocket Ping Interval:** Positive values are interpreted as number of seconds between pings. Value must be between 1 and 60s
- **Message timeout:** Interval between request and response OCPP message before considering the connection lost. Value must be between 1 and 60s
- **Forward security event to CPO:** Authorize to forward security event to supervision

3.4.2.3 Basic authentication

Add a Basic Authentication password for all charging stations to secure communication between EcoStruxure EV Charging Expert and supervision. There are 2 options:

- **One password by station:** One unique password for each station. To add or change basic authentication password, it's necessary to select charging station into installation page and click on **Change password**.

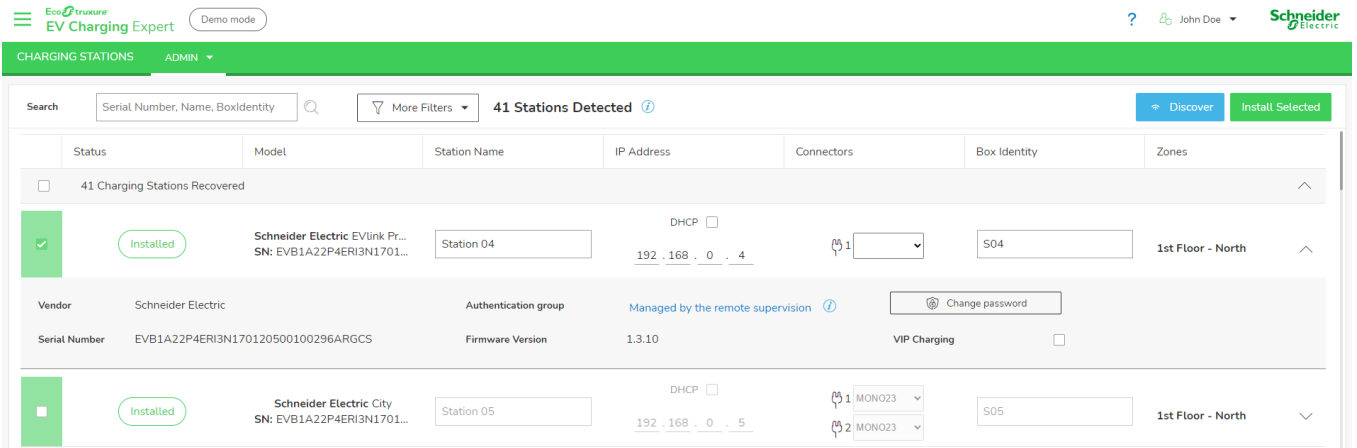

- **Same password for all charging stations:** Once the option is selected, a popup will appear offering the possibility to add basic authentication key according to 2 formats (ASCII or HEXA format). Password is used for all stations and can be changed later by supervision through OCPP commands.

3.4.2.4 Restrictions

If remote supervision option is activated, it is the responsibility of the remote supervision system to handle EV driver authentication and to consider charging station specific keys for authentication management.

When the remote supervision is activated, the date and time are provided by the remote supervision even if time zone still has to be configured in the next panel (Date & Time).

3.4.3 Multiple supervision

3.4.3.1 Supervision configuration

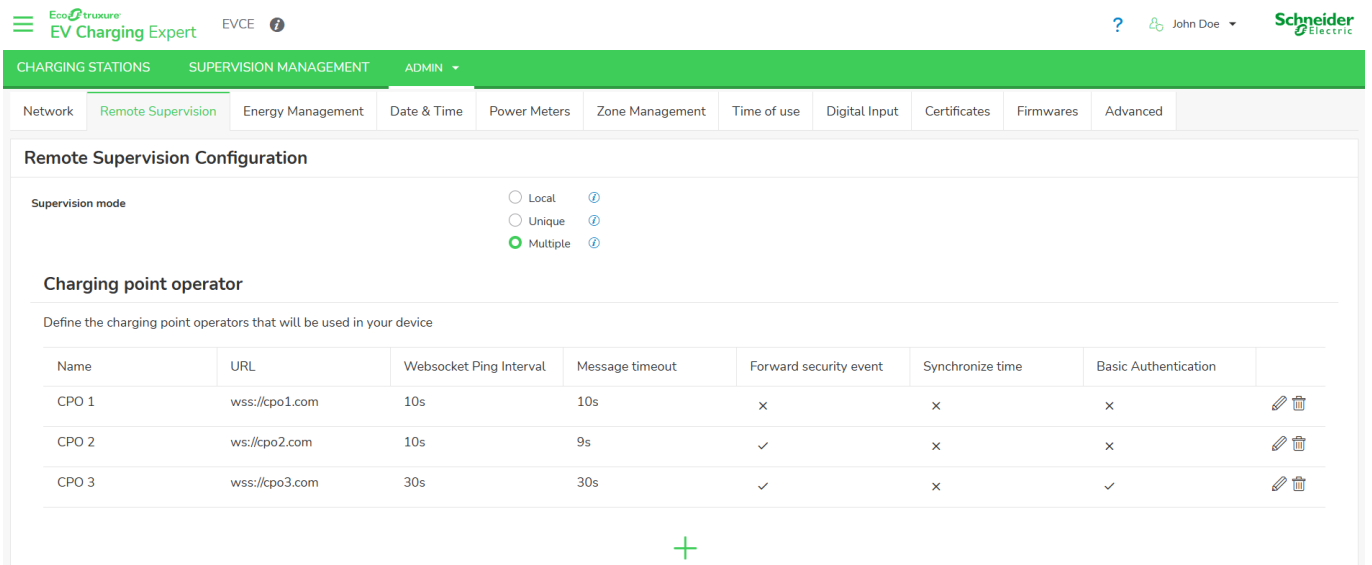

To manage supervisions, it is necessary to click on + and refer to [chapter 3.4.2](#) to configure a supervision.

3.4.3.2 Supervision management

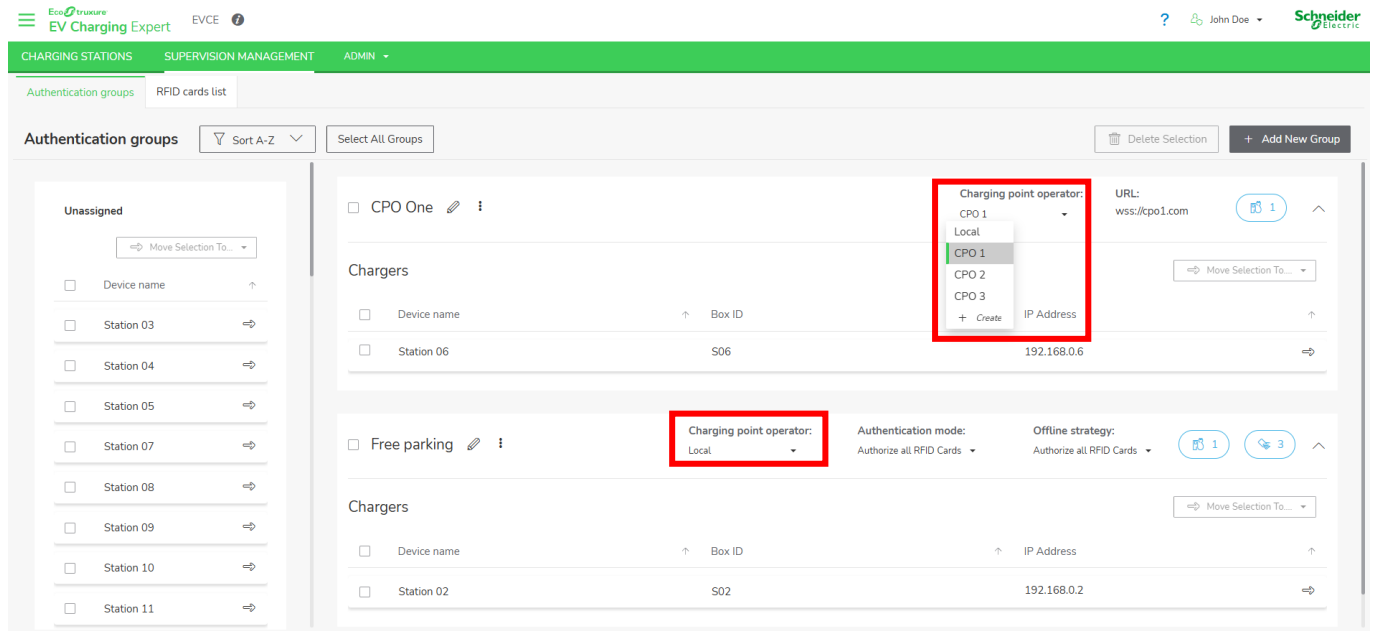

Multiple supervisions option offers the possibility to manage authentication strategy according to supervision or local strategy. To manage the installation, it is necessary to create authentication groups and assigned charging stations to a group. An authentication group is a selection of charging stations associated with to a charging point operator. There are 2 charging point operator options:

- Select a **supervision as charge point operator**: select in the list the supervision already configures.
- Select **local as charge point operator**: please see chapter [3.11.1.2](#) and to manage RFID card, please see chapter [3.11.2](#).

3.5 Energy management configuration

Access by the Admin tab → configuration → energy management

The screenshot shows the 'Energy Management' configuration page in the 'ADMIN' tab. The page is divided into several sections:

- Charging Stations Default Configuration:**
 - Minimum current setpoint for an electrical vehicle to charge: EV/ZE Ready (8A Single-phase/14A Three-phase)
 - Load Shedding Priority:
- Consumption Optimisation Configuration:**
 - Activation: ON
 - Setpoint reduction trigger value:
 - Reduction efficiency value:
 - Minimal gap with EV consumption:
 - Optimization delay (s):
- Suspended by System Strategy:**
 - Strategy: Allow, Disabled, Reused setpoint
- Electrical grid:**
 - Type of electrical network: 3 x 400V with neutral, 3 x 230V no neutral
- Local production management:**
 - Type of local production: Grid only, Local production + Grid, Local production only

A 'Save' button is located at the bottom left of the configuration area.

3.5.1 Load shedding configuration

Load shedding mechanism is activated once there is not enough available current in a zone to provide floor value to all charges simultaneously. When such a situation happens, choose between energy or duration priority: to favour the newest transactions or the transactions that delivered the lowest amount energy:

- **Energy:** Proportional to the energy consumed (kWh). Favour transaction which has delivered the lowest amount energy. This option is set by default.
- **Duration:** Proportional to the charging time. Favour transaction which has the lowest charging time

The charging station floor value is defined by IEC 61851 and EV/ZE standard for AC installation:

- IEC 61851 (6A in both single and 3-phases connection)
- EV/ZE ready (8A in single-phase, 14A in 3-phase connection)

3.5.2 Consumption optimisation configuration

Consumption optimization mechanism is activated to manage energy management with different parameters:

- **Setpoint reduction trigger value:** Difference between decreasing EV consumption and setpoint before triggering the optimization.
- **Reduction efficiency value:** Gap between the consumption and the new setpoint calculated by the optimization.
- **Minimal gap with EV consumption:** Gap between the increasing EV consumption and the setpoint triggering more power allocation to the charging station.

3.5.3 Allow Suspended by System

If a transaction stop consuming energy (current lower than 1A), EcoStruxure EV Charging Expert can pause the transaction (Suspended by System) and restart transaction after a wake-up interval defined in second.

3.5.4 Local production management

3.5.4.1 Prerequisites

To manage local production there are 3 options:

- **Grid only** (selected by default): Power coming only from grid
- **Local production + grid**: Local solar production is added to power coming from utility for higher consumption capacity.
- **Local production only**: Enable green charging by considering solar energy only as available power for your EV charging installation

3.5.4.2 Local production

If 2nd or 3rd option are chosen, then it is necessary to add power meter dedicated to solar production. Please see [chapter 3.7.2](#) to add a power meter and [chapter 3.8.3](#) to associate the local production to an electrical zone.

For reduction, when it is applied with EBMS, time of use or DI it concerned only the maximum current of the zone, additional current provides by local production are not consider.

For example, a zone with 100A a reduction to 70% with a solar production of 20A. After energy management computation there is 90A available for the charging stations.

Note: The power meter wiring must include a neutral and be wired in the correct direction. Failure to follow these instructions can result in an installation trip.

3.5.4.3 Example

For the example, there is a dynamic electrical zone on 70A with solar production and 3 charging stations associate to the electrical zone.

The schematic of the installation:

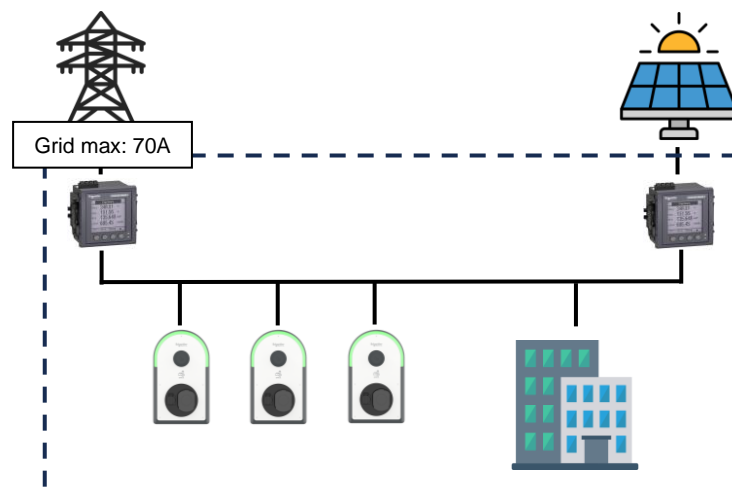

Zone configuration: Main zone has 70A maximum current and MainPowerMeter is the power meter associate to the electrical zone to compute consumption of charging stations and building. SolarPowerMeter is the power meter associate to the local production into the electrical zone.

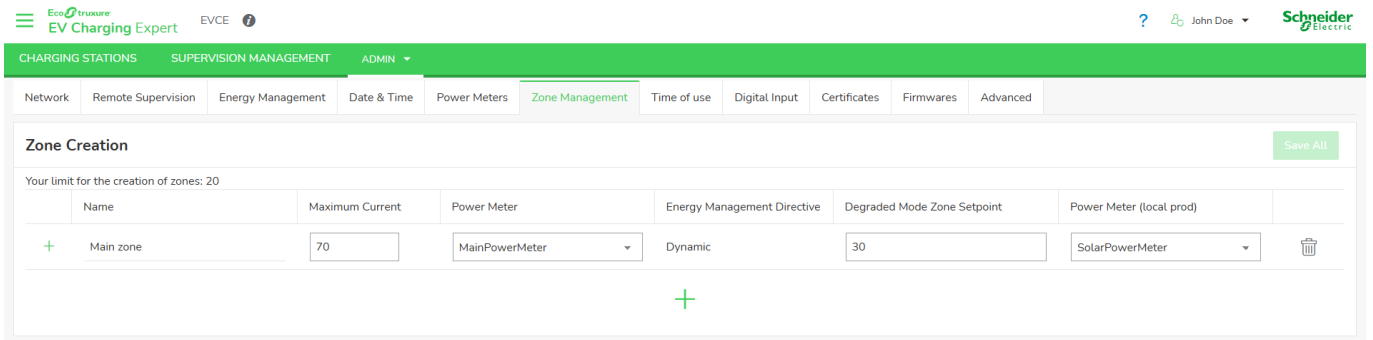

Dashboard:

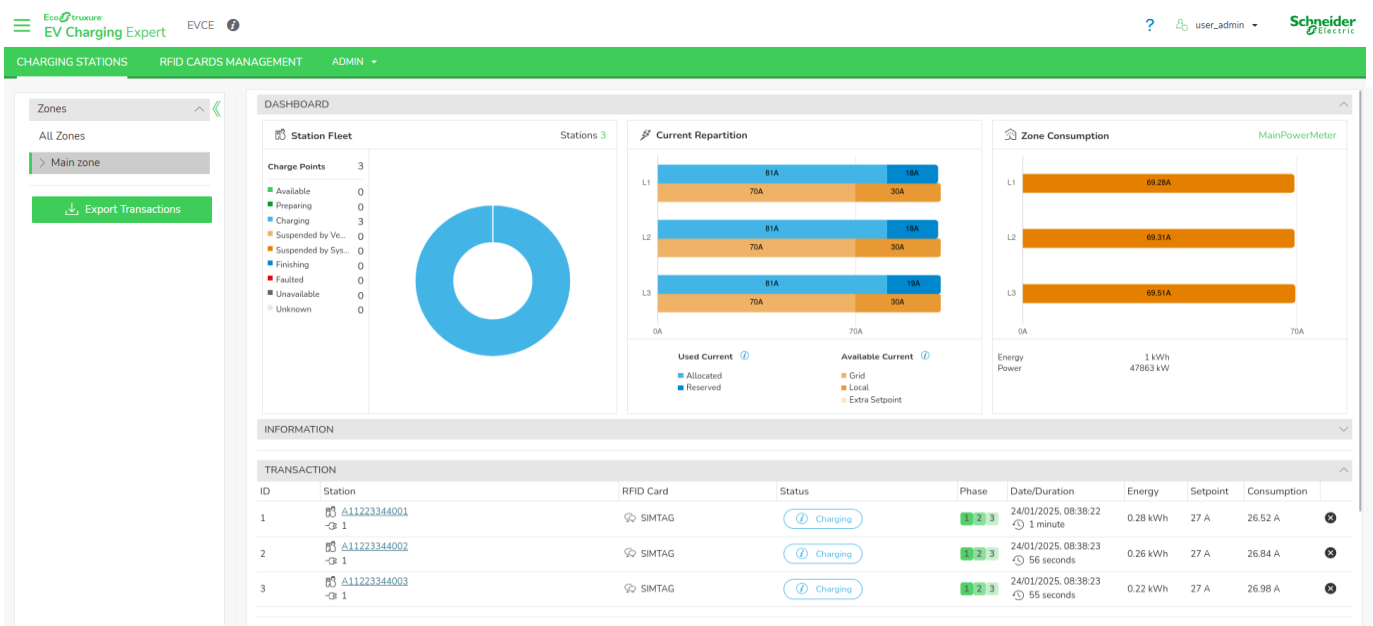

On the dashboard there is 3 transactions in progress, maximum current of the zone is 70A but it is increase to 100A with 30A of local production. And the building consumes 19A. So the energy management computation gives 27A for each transaction:

$$\frac{(Max\ current+Local\ production)-Building\ consumption}{Number\ of\ transaction} = \frac{(70A+30A)-19A}{3} = 27A$$

3.6 Charging stations commissioning

Access by Admin tab → configuration → Installation

3.6.1 Prerequisites

Charging stations must be powered on and connected to the network before the EcoStruxure EV Charging Expert commissioning. Charging stations must have a compatible firmware version, see [chapter 1.1.2.1 EVlink charging stations](#)

NOTICE

IMPOSSIBLE TO INSTALL CHARGING STATION WITH WEBSERVER OPENED.

Close charging station webserver

Failure to follow these instructions can result in an impossibility of installing a charging station.

NOTICE

RESTRICTIONS ON CHARGING STATIONS IP ADDRESSES AND BOX IDENTITIES

- Avoid the use of sub-network addresses +0, +MAX, +MAX-1. If the by-default sub-network (192.168.0.0-255) is being used, avoid the use of 192.168.0.0, 192.168.0.254 and 192.168.0.255.
- Charging stations box identities must contain only a-z, A-Z, 0-9, '*', '-', '_', '=', '+', '|', '@', '!'.
- Charging stations box identities should not contain any space
- Charging stations box identities must not exceed 30 characters
- Charging stations box identities must be unique by station.

Failure to follow these instructions can result in an impossibility of installing a charging station.

3.6.2 Charging station installation page

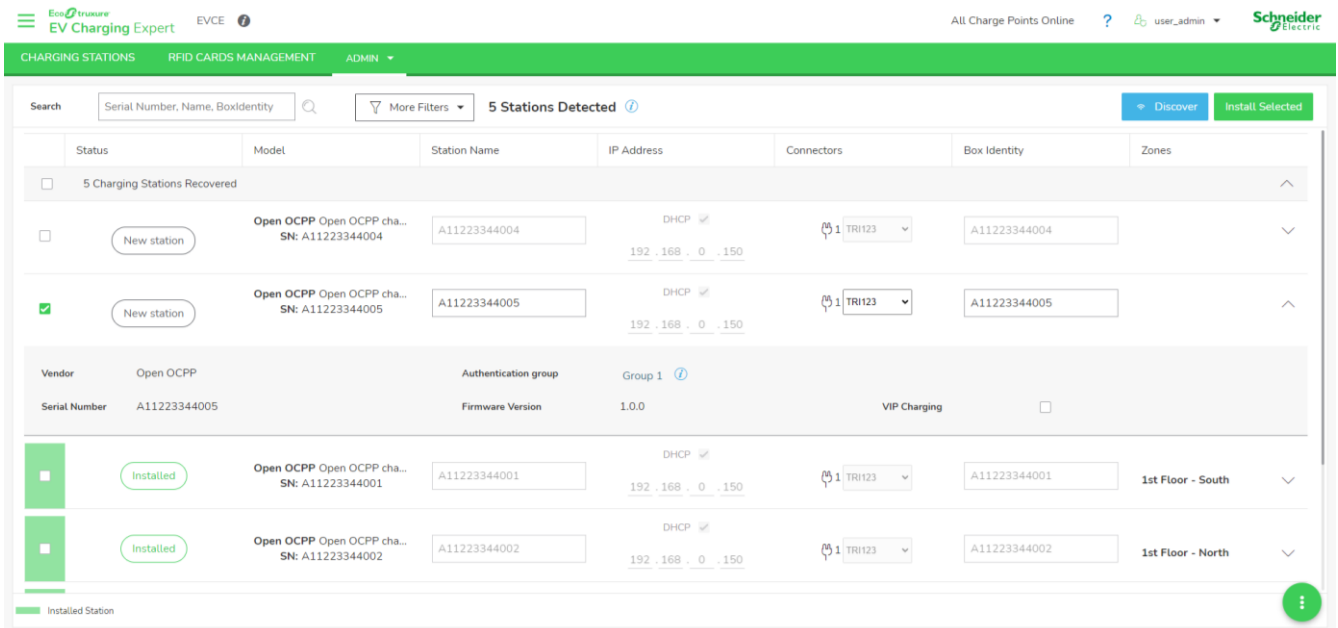

All charging stations already installed are present into the installation page before to launch a network discovering. To detect all new charging stations and proceed to installations, first click on **Discover** button to launch a network scan of all stations.

3.6.3 Charging station status

In charging station installation page after a discovery, some stations may not be installed. Below are the possible reasons:

- Current charging station version is not supported by EcoStruxure EV Charging Expert (see [chapter 1.1.2.1](#)). In this case the station must be upgraded to a compatible version first.

<input type="checkbox"/>	Warning	Schneider Electric EVlink Pr... SN: A21301010232	192.168.0.223	Information Unable to install this station with current version 1.3.7. Upgrade the station's firmware to 1.3.8 or later.	Troubleshoot Remove
--------------------------	----------------------	---	---------------	--	------------------------

- It is impossible to establish a connection with charging station. Try to perform a manual installation (see [chapter 3.5.5](#)) or perform a back to factory of the charging station.

<input type="checkbox"/>	Error	Schneider Electric EVlink Pr... SN: R23054000005	192.168.0.10	Information Error during last saving/discovering. Please redo last action	Troubleshoot Remove
--------------------------	--------------------	---	--------------	---	------------------------

- Charging station is newly discovered and ready to be installed into EcoStruxure EV Charging Expert.

<input type="checkbox"/>	New station	Open OCPP Open OCPP cha... SN: A11223344004	A11223344004	DHCP <input checked="" type="checkbox"/>	192 . 168 . 0 . 150	TR1123	A11223344004	▼
--------------------------	--------------------------	--	--------------	--	---------------------	--------	--------------	---

- Charging station already installed into EcoStruxure EV Charging Expert.

<input checked="" type="checkbox"/>	Installed	Open OCPP Open OCPP cha... SN: A11223344001	A11223344001	DHCP <input checked="" type="checkbox"/>	192 . 168 . 0 . 150	TR1123	A11223344001	1st Floor - South ▼
-------------------------------------	------------------------	--	--------------	--	---------------------	--------	--------------	---------------------

3.6.4 Charging station configuration

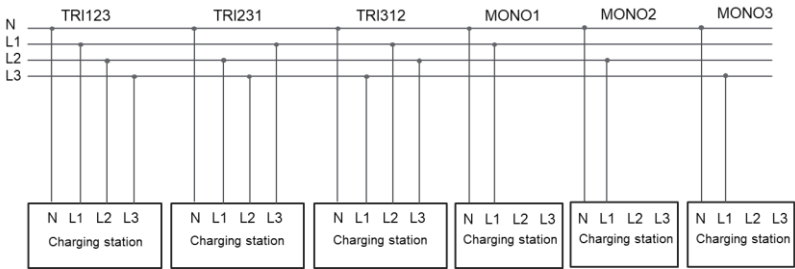
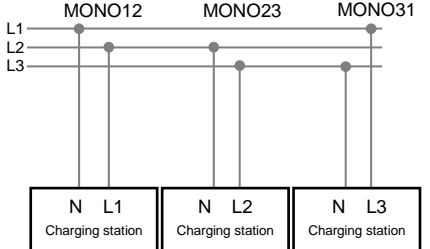
Steps	Description
1	Click on  to discover new charging station to install and present into the network
2	Update charging station settings: <ul style="list-style-type: none"> • Station name: Select a name to identify your charging station. (max 30 characters) • IP Address: 2 options: <ul style="list-style-type: none"> ○ DHCP activated: Select DHCP if there is a DHCP server activated (in EcoStruxure EV Charging Expert or local network). ○ DHCP deactivated: Set IP address according to network architecture. • Connector(s): Select the phase wiring of each connector in charging station according to electrical cabling. <i>example for 3 x 400V with neutral:</i>  <i>example for 3 x 230 without neutral:</i>  <ul style="list-style-type: none"> • Box identity: If a supervision is activated, select the name configured by supervision to identify the charging station. Otherwise select a name to identify the charging station. • Zones: Zone assignment, see chapter 3.7.5
3	Advanced details and configuration: <ul style="list-style-type: none"> • Vendor: Charging station vendor • Serial number • Authentication group: Authentication group assignment, see chapter 3.11.1 • Version: Charging station firmware version • VIP Charging: Check the box to activate the VIP status of the charging station. Note: a VIP station status provides VIP privileges on load balancing. It means maximum energy will always be allocated to this station before the others. • Change password: when one password by station is selected, there is the possibility to add a password for each charging station with hexa or ascii format.

3.6.5 Manual charging station configuration

If a charging station is not detected automatically during scan, it is possible to declare it manually with OCPP or IP address (only for EVlink Pro AC, Schneider Charge Pro or EVlink City / Parking / Smart Wallbox).

3.6.5.1 OCPP configuration

To install a new charging station with OCPP, it is mandatory to first update charging station configuration:

- **Supervision URL:** add EcoStruxure EV Charging Expert URL. For unsecure connection:
 - ws://XXX.XXX.XXX.XXX:9979 – No security profile

For secure connection, add **OCPP certificate** (see [chapter 3.12](#)) and update supervision URL:

- wss://XXX.XXX.XXX.XXX:9980 – Activate security profile 0 with WebSocket secure.
- wss://XXX.XXX.XXX.XXX:9981 – Activate security profile 1.
- wss://XXX.XXX.XXX.XXX:9982 – Activate security profile 2.

Replace: XXX.XXX.XXX.XXX by EcoStruxure EV Charging Expert IP address.

- **Webserver certificate:** mandatory to get maintenance report and update charging station.

To complete the installation, please return to the installation page.

3.6.5.2 IP address configuration

Install a new charging station with IP address is available only for EVlink Pro AC, Schneider Charge Pro or EVlink City / Parking / Smart Wallbox. After clicking on +, a popup will appear to select the charging station model and IP address.

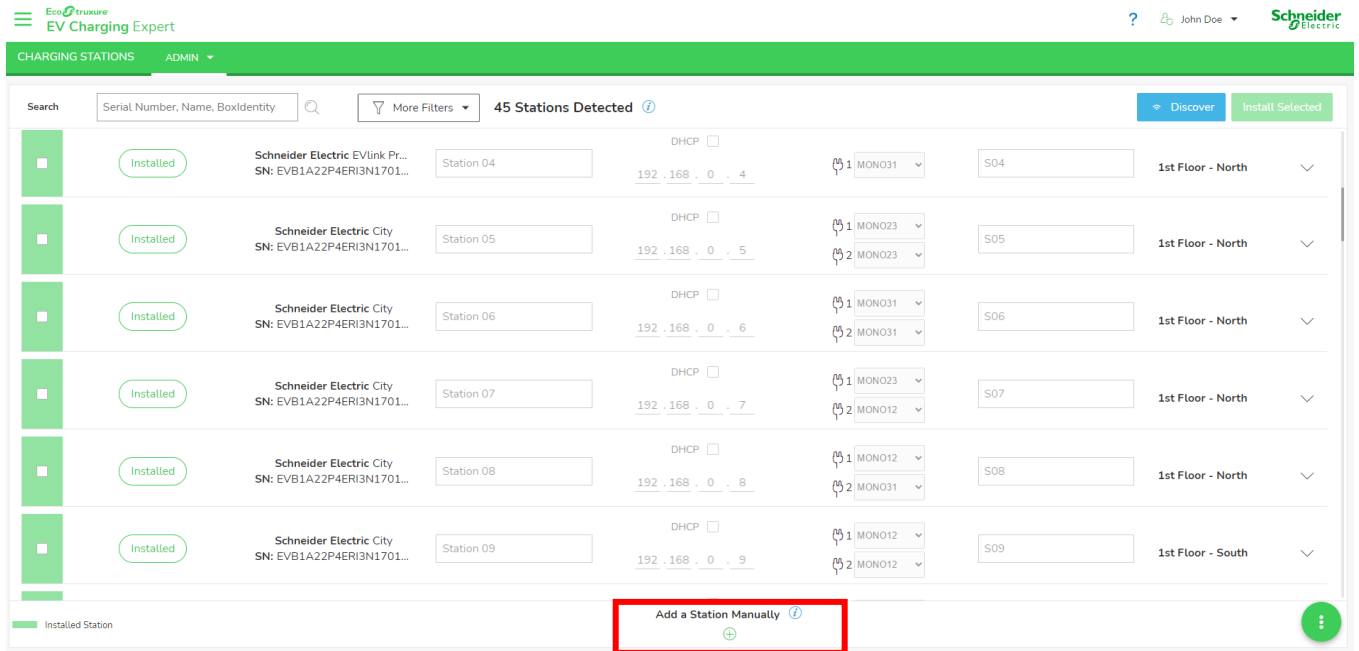

Once information is confirmed, to complete the installation, please return to the installation page to see charging station.

3.6.5.3 Get the serial number of a charging station

For EVlink Parking, EVlink Smart WallBox and EVlink City it is mandatory to add **Serial Number**:

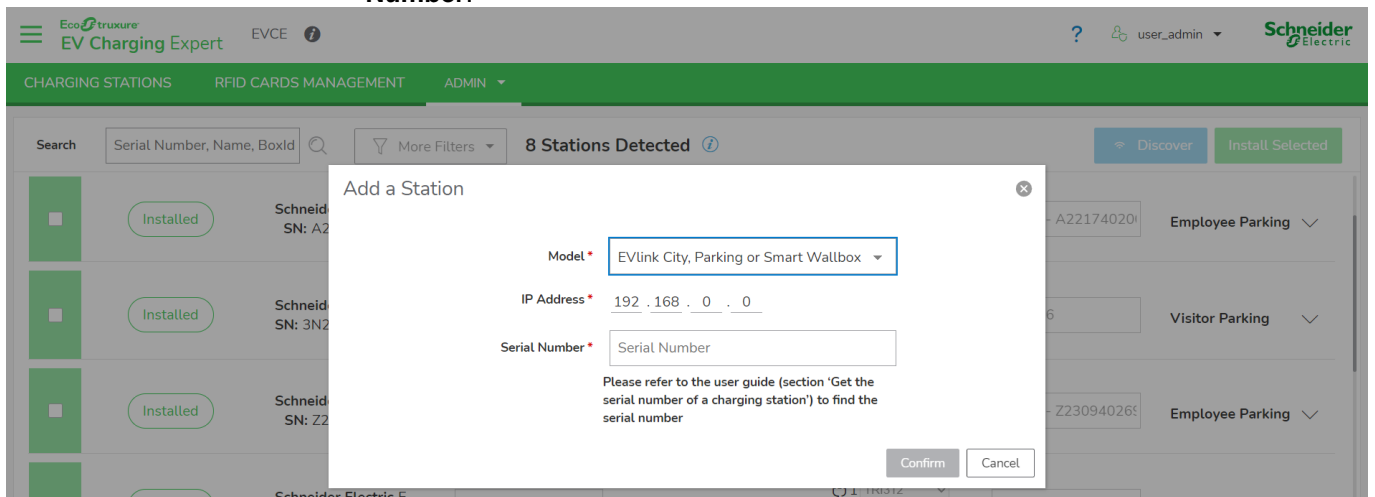

To add Serial number, it is necessary to connect to the webserver interface of the charging station : Maintenance > Report. The concatenation of Serial Number Part 1 & Serial Number Part 2 gives the serial number of the charging station.

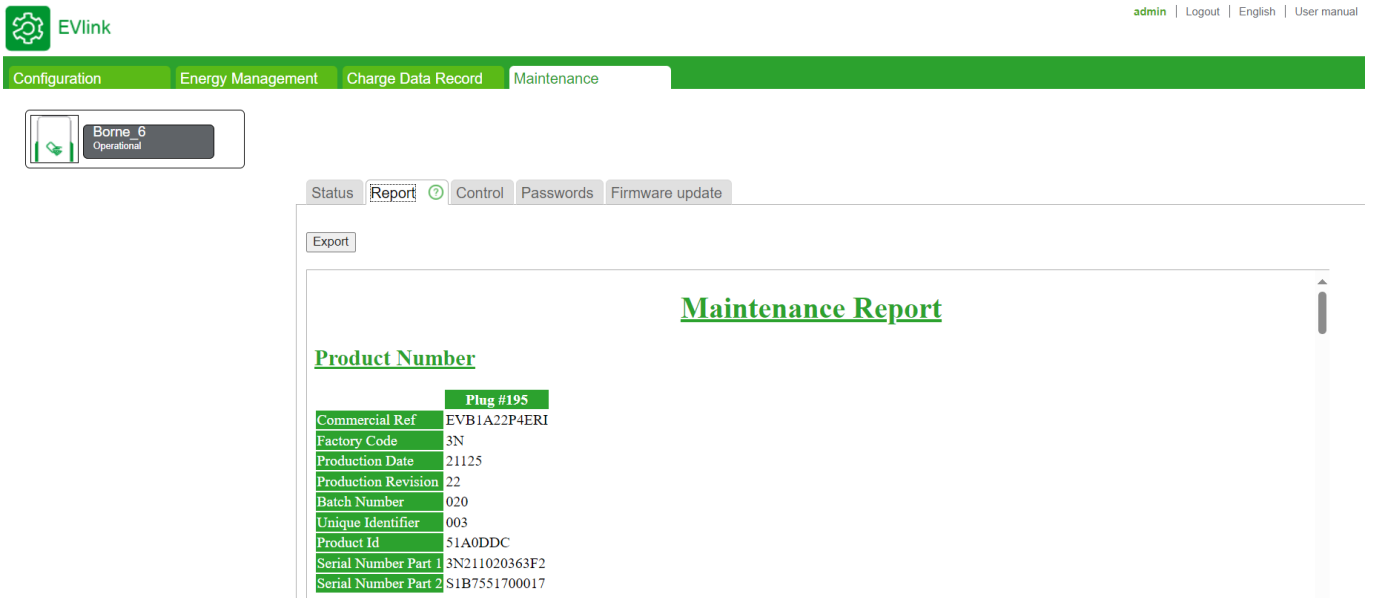

The screenshot shows the EVlink web interface. At the top, there is a navigation bar with 'Configuration', 'Energy Management', 'Charge Data Record', and 'Maintenance'. Below this, there is a 'Borne 6 Operational' status indicator. The main content area is titled 'Maintenance Report' and contains a table of product details. The table includes fields such as Commercial Ref, Factory Code, Production Date, Production Revision, Batch Number, Unique Identifier, Product Id, Serial Number Part 1, and Serial Number Part 2. The Serial Number Part 1 is 3N211020363F2 and Serial Number Part 2 is S1B7551700017.

Plug #195	
Commercial Ref	EVB1A22P4ERI
Factory Code	3N
Production Date	21125
Production Revision	22
Batch Number	020
Unique Identifier	003
Product Id	51A0DDC
Serial Number Part 1	3N211020363F2
Serial Number Part 2	S1B7551700017

ei. :

With this image above the concatenation of the serial number will be the following:
3N211020363F2S1B7551700017

3.7 Power meter configuration

Access by Admin tab → configuration → Power meters

Define the power meters that will be used in your device

Status	Name	Model	Network Configuration	Current (A)	Energy (kWh)	Power (kW)	Edit	Delete
✓	Test	pm5320	TCP 192.168.0.150:502 #255	0 / 0 / 0	0	0		
✗			TCP 192.168.0.0:502 #255					

Name *

RTU

Model

IP Address * 192 . 168 . 0 . 0

IP Port * 502

Slave ID * 255

3.7.1 Prerequisites

Power meters are only required in EcoStruxure EV Charging Expert dynamic mode. Ethernet connection must be configured (see [chapter 1.3.1.2](#)) regardless of the EcoStruxure EV Charging Expert and prior to the commissioning.

3.7.2 Manage Power Meters

Name *

RTU

Model

IP Address * 192 . 168 . 0 . 0

IP Port *

Slave ID *

Two options to connect power meter EcoStruxure EV Charging Expert:

- TCP: Connection is made directly with the product through the network. It is mandatory to provide the IP address and port of power meter.
- RTU: The connection is established directly with power meter using RS485 cable and USB adaptor. The power meter configuration should be:
 - **Baud Rate:** 19200 bits per second (bps). This determines the speed at which data is transmitted over the serial communication line.
 - **Data Bits:** 8. Each character is represented by 8 bits of data.
 - **Parity:** None. No parity bit is used for error checking.
 - **Stop Bits:** 1. One stop bit is used to signal the end of each character.

For both solutions, it's mandatory to select a supported model (see [chapter 1.1.1.8](#)) or customized model (see [chapter 3.6.3](#)). Power meter slave id matches the power meter Modbus configuration at this IP address (see [chapter 1.3.1.2](#)).

As soon as the power meter(s) are defined and updated, status column indicate connection status of device with EcoStruxure EV Charger Expert.

3.7.3 Define a new power meter model

Power Meters Manage Power Meters Define Power Meter Models Power Meter Configuration

Configure new power meter models Save Cancel Import Export

Power Meter Models

- pm5320
- iem3x5x
- Power Tag A
- NSX legacy
- NSX
- MTZ

Model Name:

Registers

RMS Current on Phase 1		RMS Current on Phase 2		RMS Current on Phase 3	
Address	<input type="text" value="1"/>	Address	<input type="text" value="2"/>	Address	<input type="text" value="3"/>
Format	<input type="text" value="float32"/>	Format	<input type="text" value="float32"/>	Format	<input type="text" value="float32"/>
Type	<input type="text" value="Holding Register"/>	Type	<input type="text" value="Holding Register"/>	Type	<input type="text" value="Holding Register"/>
Scale Factor	<input type="text" value="1"/>	Scale Factor	<input type="text" value="1"/>	Scale Factor	<input type="text" value="1"/>
Endian	<input type="radio"/> Little Endian <input checked="" type="radio"/> Big Endian	Endian	<input type="radio"/> Little Endian <input checked="" type="radio"/> Big Endian	Endian	<input type="radio"/> Little Endian <input checked="" type="radio"/> Big Endian
Active Power on Phase 1		Active Power on Phase 2		Active Power on Phase 3	
Address	<input type="text" value="4"/>	Address	<input type="text" value="5"/>	Address	<input type="text" value="6"/>
Format	<input type="text" value="float32"/>	Format	<input type="text" value="float32"/>	Format	<input type="text" value="float32"/>
Type	<input type="text" value="Holding Register"/>	Type	<input type="text" value="Holding Register"/>	Type	<input type="text" value="Holding Register"/>
Scale Factor	<input type="text" value="1"/>	Scale Factor	<input type="text" value="1"/>	Scale Factor	<input type="text" value="1"/>

- Click on **+** to create a new power meter model.
- Enter a name to the new model.
- Fill the fields in each register:
 - Modbus register address
 - Format (float32, int64, int32, int16, uint64, uint32, uint16)
 - Type (Holding or Input register)
 - Scale factor. In case "Scale factor" is 1, values are expected as units:
 - Amps for current measurements (10 000 as RMS current with Scale factor 0.001 is considered as 10Amps)
 - kW for power measurements (1 000 as active power with Scale factor 0.1 is considered as 100kW)
 - kWh for energy measurements
- Save the new power meter model.

3.8 Zone configuration

Access by the Admin tab → configuration → zone management

3.8.1 Prerequisites

At zone or subzone creation, it is important to define a maximum current limitation. To declare a zone as dynamic (for dynamic load balancing), simply assign a power meter to the electrical zone (configured power meter [chapter 3.6.2](#)).

3.8.2 Zone configuration

EcoStruxure EV Charging Expert can manage different zones and subzones based on the electrical architecture deployed in the installation. Please refer to [chapter 1.4](#).

3.8.3 Zone creation

Step	Comments
1	Click on + to create a zone.
2	Click on + next to Zone name to create a subzone .
3	Set the maximum current allowed in zone or subzone. Note: <ul style="list-style-type: none"> • The value must be lower or equal to the electrical capacity of the installation. • Max intensity in a sub-zone cannot be higher than the maximum intensity in the related zone.
4	To create a dynamic zone , select the power meter measuring the zone current. A power meter is assigned to a single zone and cannot be shared .
5	For the dynamic zone, set a Degraded Setpoint , it's used when the communication is lost with the power meter. <u>This corresponds to the amount of power that is always available for EV charging, irrespective of other electrical loads in the same zone.</u>
6	Only for local production, select the power meter measuring the local production energy. A power meter cannot be shared.

To delete an electrical zone, it is necessary to delete previously all charging stations assigned to this electrical zone.

3.8.4 Degraded Mode

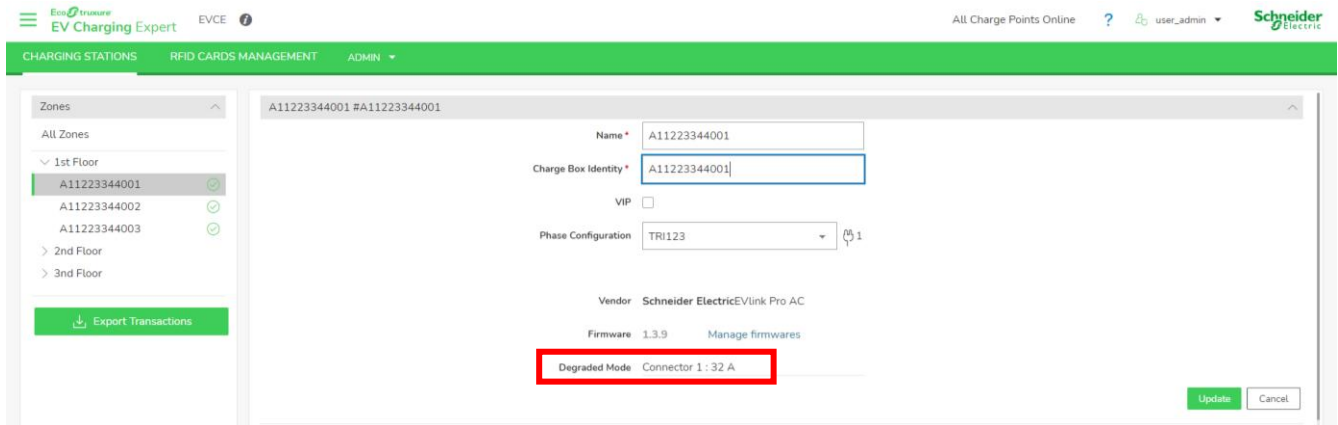

Degraded mode allows charging stations to continue charging, even if there is communication loss with EcoStruxure EV Charging Expert. For each charging station connector, an offline maximum current is calculated according to:

- Maximum current of static zone
- Degraded Mode Zone Setpoint of a dynamic zone (refer below)

For a dynamic zone, a **Degraded Mode Zone Setpoint** defines the maximum current that is always available for EV charging irrespective of other loads in same electrical zone. Ensure degraded mode zone setpoint defined for dynamic zone is enough to manage charging stations even if EcoStruxure Charging Expert loses building consumption information. For dynamic zone, offline management is active when communication is lost with charging station or power meter dedicated to the zone.

Examples:

Static zone:

Static zone characteristics:

- Maximum current: 60A
- 3 EVlink Pro AC (1 connector)

Degraded calculation: $60/3 = 20$, for each connector 20A should be available even if connection is lost with EcoStruxure EV Charging Expert.

Static zone with reduction:

Static zone characteristics:

- Maximum current: 60A
- 3 EVlink Pro AC (1 connector)
- Reduction to 80% – Only 48A are now available.

Degraded calculation: $48/3 = 16$, for each connector 16A should be available even if connection is lost with EcoStruxure EV Charging Expert.

Dynamic zone:

Dynamic zone characteristics:

- Degraded Mode Zone Setpoint: 30A
- 3 EVlink Pro AC (1 connector)

Degraded calculation: $30/3 = 10$, for each connector 10A should be available even if connection is lost with power meter.

3.8.5 Charging station electrical zone assignation

To manage charging stations, it is required to assign charging stations to electrical zone previously configured. A station can be assigned only to a terminal zone (zone without subzone).

To assign station in an electrical zone:

- Select multiple charging stations, click on **Move Selection To** and select an electrical zone.
- Click on charging station \Rightarrow and select an electrical zone.

3.9 Time Of Use

Access: Admin tab → Configuration → Time-of-use

3.9.1 Definition

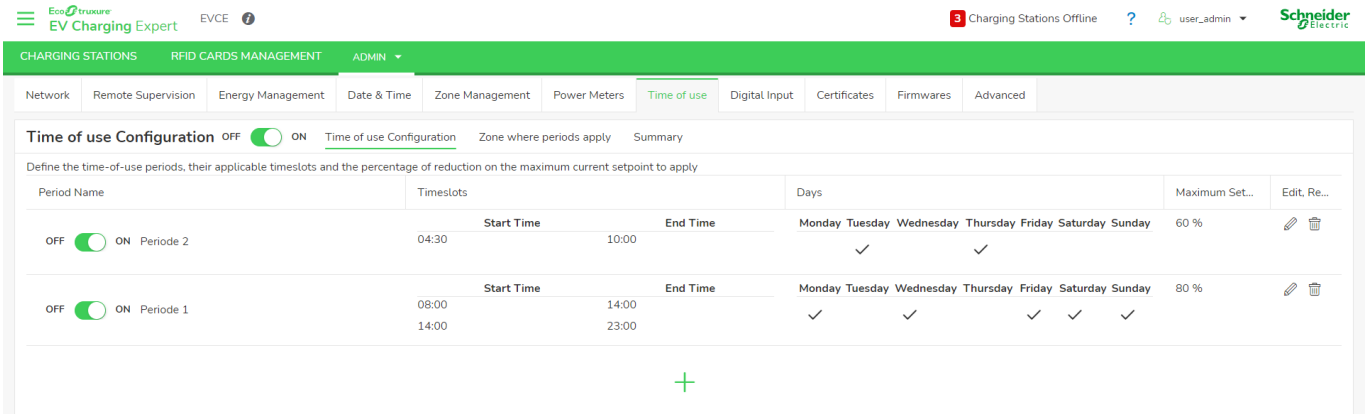

Use Time Of Use (TOU) configuration to reduce the power capacity per zone depending on day/time to match the local tariff policy.

A total of 5 periods and 20 timeslots can be configured. A period is defined by:

- **Days:** Selected days where timeslots are applied.
- **Timeslots:** Start and stop time when reduction is applied.
- **Reduction:** Ratio of the maximum current of a zone. For example, for a zone with a maximum setpoint of 100A, if a ratio at 80% is applied then the new maximum setpoint is 80A for the zone.

When digital input functionality is activated, the time of use configuration is no more considered.

3.9.2 Prerequisites

At least one zone must be created (see [chapter 3.7](#)).

3.9.3 Time Of Use configuration tab

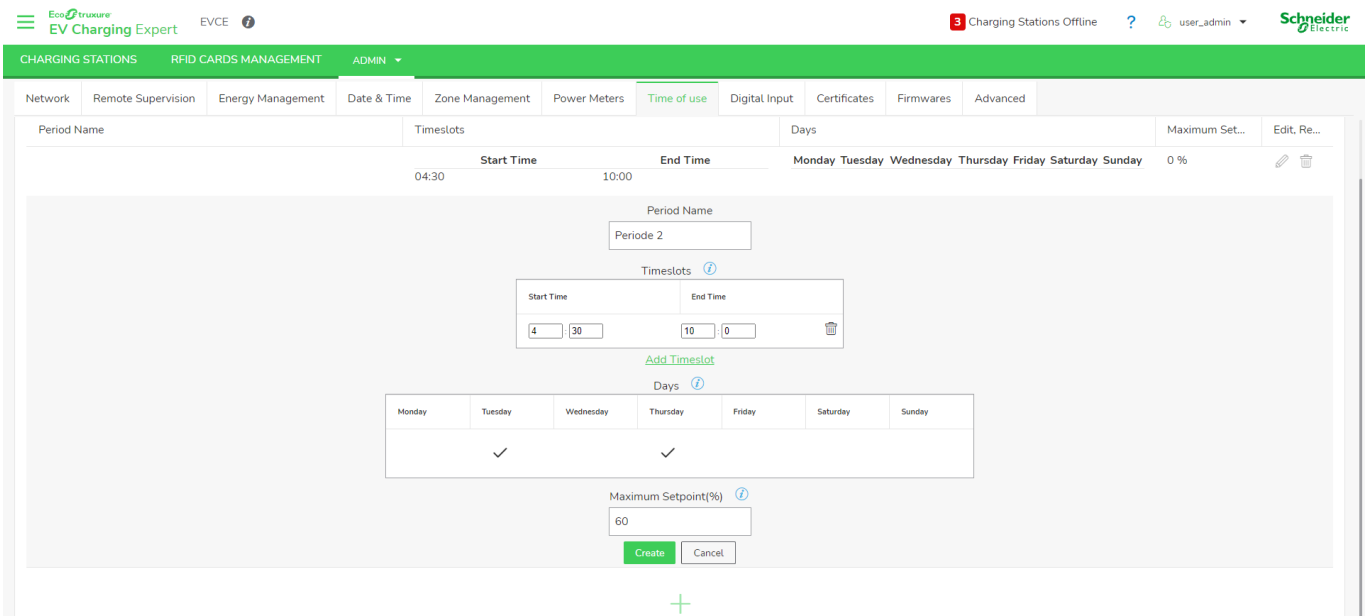

step	comments
1	Click on + icon to create a tariff period.
2	Enter period Name
3	Define Timeslots : <ul style="list-style-type: none"> • Start time • Stop time • Clicking on 'Add a timeslot' to add another timeslot for this reduction
4	Define Days when timeslots are applied
5	Define a ratio (percentage) of Maximum setpoint reduction

3.9.4 Zone configuration tab

For each reduction, it is possible to assign one or more periods to a zone.

The screenshot shows the 'Time of use Configuration' interface. At the top, there is a navigation bar with 'CHARGING STATIONS', 'RFID CARDS MANAGEMENT', and 'ADMIN'. Below this, a sub-menu includes 'Network', 'Remote Supervision', 'Energy Management', 'Date & Time', 'Zone Management', 'Power Meters', 'Time of use', 'Digital Input', 'Certificates', 'Firmwares', and 'Advanced'. The 'Time of use' section is active, showing a toggle for 'Time of use Configuration' (OFF/ON) and tabs for 'Time of use Configuration', 'Zone where periods apply', and 'Summary'. The main content area is titled 'Select the parking zones where the different periods apply' and contains a table with columns for 'Zone', 'All Periods', 'Periode 1', 'Periode 2', and 'Periode 3'. Each cell in the table contains 'OFF' and 'ON' toggle switches.

Zone	All Periods	Periode 1	Periode 2	Periode 3
1st Floor	OFF <input checked="" type="checkbox"/> ON	OFF <input checked="" type="checkbox"/> ON	OFF <input checked="" type="checkbox"/> ON	OFF <input checked="" type="checkbox"/> ON
2nd Floor	OFF <input type="checkbox"/> ON	OFF <input type="checkbox"/> ON	OFF <input type="checkbox"/> ON	OFF <input type="checkbox"/> ON
3rd Floor	OFF <input type="checkbox"/> ON	OFF <input type="checkbox"/> ON	OFF <input type="checkbox"/> ON	OFF <input type="checkbox"/> ON

3.9.5 Summary tab

Summary tabs displays maximum current reduction applied to each zone and period.

The screenshot shows the 'Summary' tab of the 'Time of use Configuration' interface. It displays the resulting maximum current per period and per zone based on defined time-of-use settings. The table has columns for 'Zone', 'Nominal Current (A)', 'Current on "Periode 1" (A)', and 'Current on "Periode 2" (A)'. The 'Current on "Periode 2" (A)' column is currently empty for all zones.

Zone	Nominal Current (A)	Current on "Periode 1" (A)	Current on "Periode 2" (A)
1st Floor	500	300	0
2nd Floor	500	500	500
3rd Floor	300	300	300

3.10 Digital Inputs

Access: Admin tab → Configuration → Digital Input

3.10.1 Definition

EcoStruxure EV Charging Expert digital inputs (DI) are accessible through GPIO connections located on the rear side. Activation of a digital input reduces maximum zone current according to its configuration.



3.10.2 Commissioning

The screenshot shows the 'Digital Input Configuration' page in the EcoStruxure EV Charging Expert web interface. The page title is 'Digital Input Configuration' and it includes a subtitle: 'Define the % to apply on maximum current setpoint based on the state of the digital inputs'. The interface features a table with columns for '# Digital Input', 'Name', 'Reduction', and 'Edit'. There are three rows of digital inputs, each with a toggle switch (OFF/ON) and a percentage reduction set to 0%. A modal form is open for editing the first input, showing fields for 'Name' (input1) and 'Reduction' (0). The interface also includes a 'Save' button and a 'Cancel' button.

# Digital Input	Name	Reduction	Edit
OFF <input checked="" type="checkbox"/> ON 1	input1	0 %	
OFF <input checked="" type="checkbox"/> ON 2	input2	0 %	
OFF <input checked="" type="checkbox"/> ON 3	input3	0 %	

Each digital input can be activated or deactivated separately. Settings:

- **Name**
- **Maximum Setpoint:** Reduction (percentage) applied to EcoStruxure EV Charging Expert zones.

3.10.3 Electrical connection

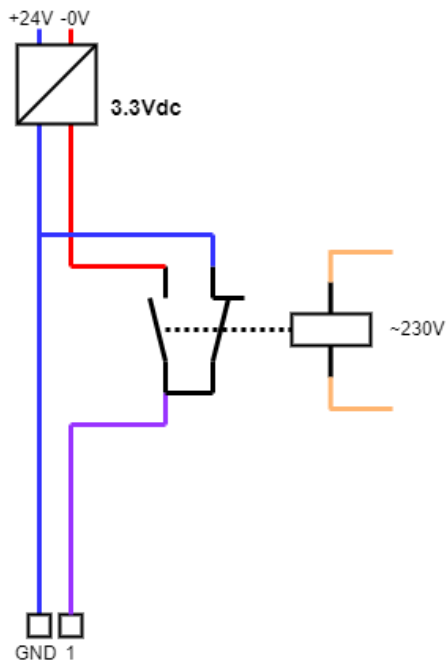

Only digital inputs 1, 2 & 3 are driven by GPIO channels 1, 2 & 3. To activate a digital input, it must be powered to 3.3 Vdc TTL.

3.11 Local authentication management

When there is no configured supervision, the EcoStruxure EV Charging Expert offers the possibility to manage authentication strategy to grant access to the charging stations.

The RFID cards management feature is made of two parts:

- Authentication groups of chargers
- RFID cards

3.11.1 Authentication group

An authentication group is a selection of charging stations associated with a list of RFID cards. Each authentication group has its own online and offline authentication strategies.

Each charging station can only be associated with a single authentication group when RFID cards can be assigned to several groups (see [chapter 3.11.2](#)).

3.11.1.1 First installation

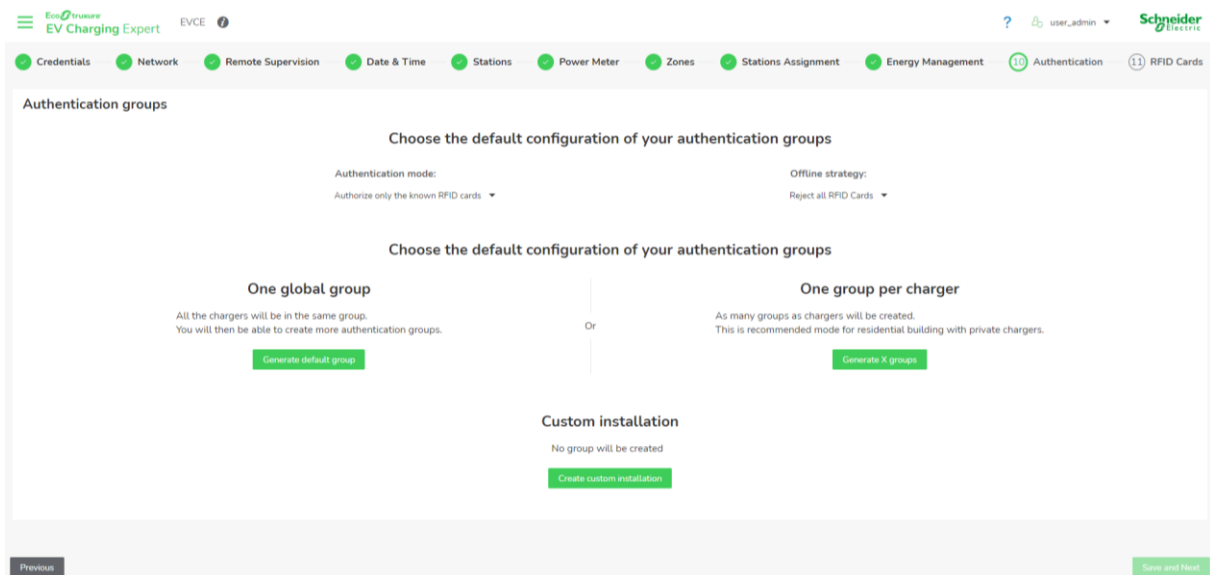

At first installation, three options are proposed:

- One global group: All installed chargers will be assigned to one authentication group.
- One group per charger: An authentication group is created for each charging station (best solution to manage one RFID badge for one charging station).
- Custom installation: Create one or multiple authentication groups according to installation needs.

After configuration, it is possible to change authentication configuration from **Admin** panel.

3.11.1.2 Authentication group management

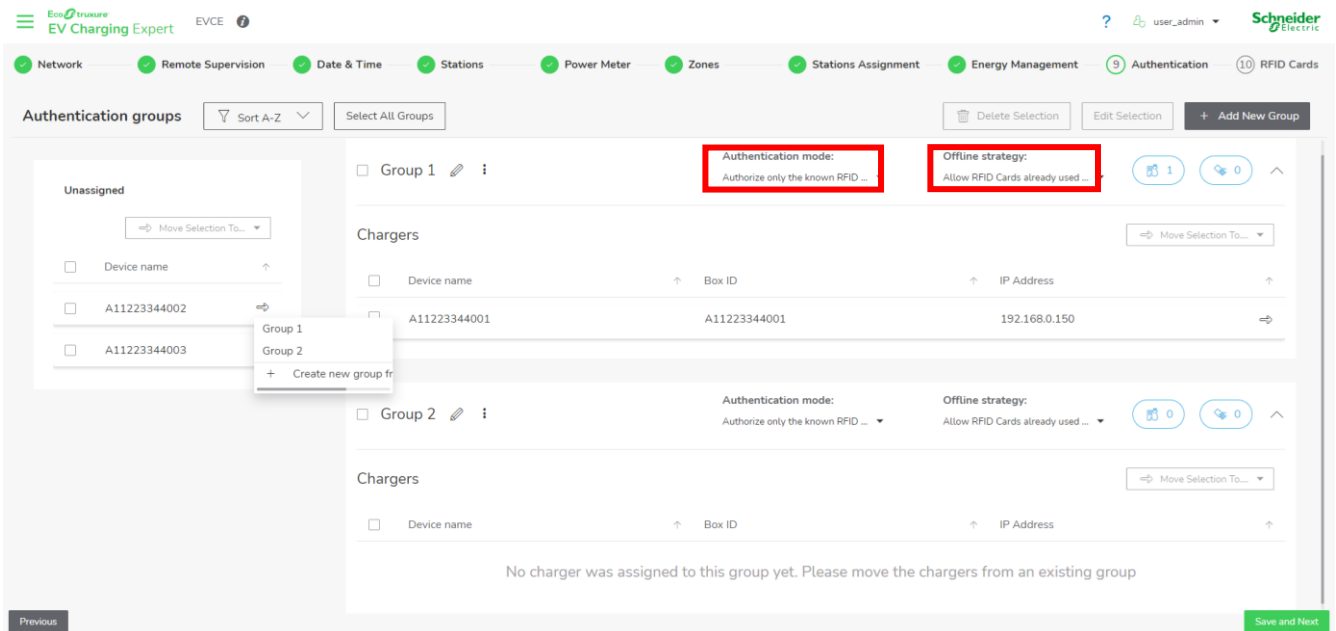

In authentication group management, **online** and **offline** authentication strategies are defined.

About **Authentication mode**:

- **Authorize all RFID cards**: Charging station starts a transaction only if EV driver uses a RFID card on the charging station (whatever is RFID).
- **Authorize only the known RFID cards**: Charging station starts a transaction only if EV driver uses a RFID card known by EcoStruxure EV Charging Expert.
- **Disable RFID card reader**: Charging station starts a transaction when EV is plugged without any other action.

About **Offline strategy**, the charging station disconnected from EcoStruxure EV Charging Expert behaves as below:

- **Authorize all RFID cards**: Charging station starts a transaction only if EV driver uses a RFID card on the charging station.
- **Reject all RFID cards**: No transaction is allowed when charging station is disconnected from EcoStruxure EV Charging Expert.
- **Using cache**: Offline charging station starts a transaction only if RFID card was already used on the charging station when it was online and accepted by EcoStruxure EV Charging Expert.

3.11.2 RFID cards

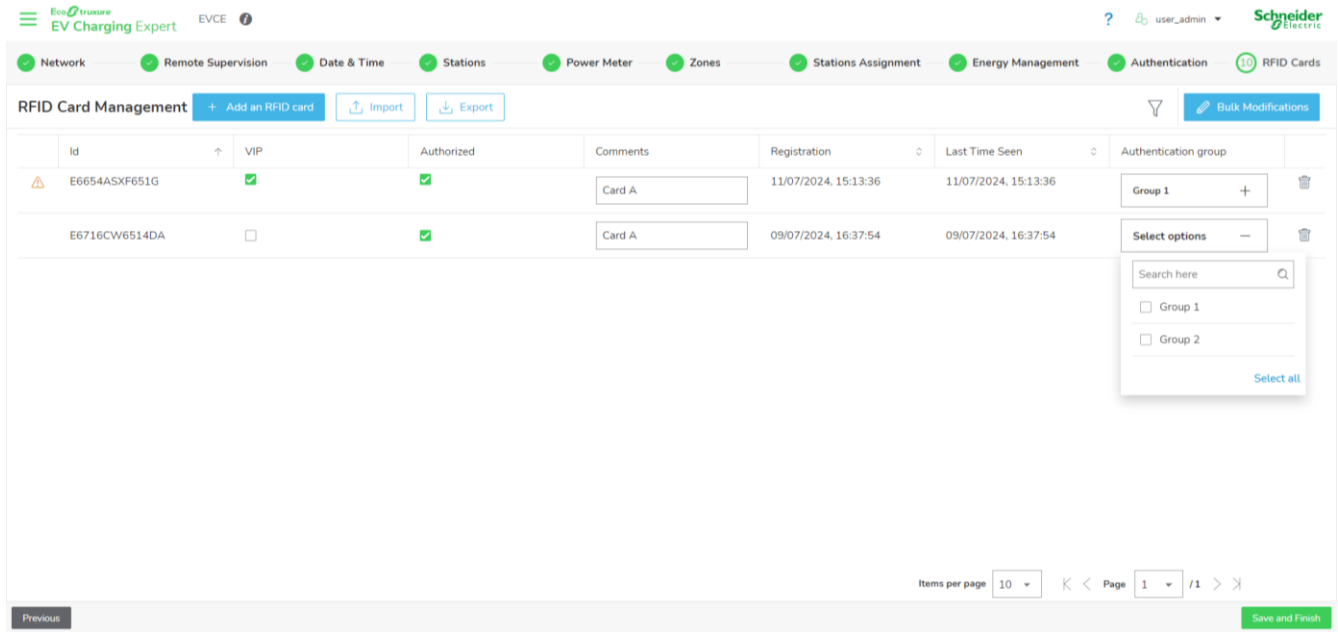

3.11.2.1 Add RFID card

In the EcoStruxure EV Charging Expert, a RFID card is added with below details:

- **VIP:** Provide VIP privileges, EV driver will have priority in load management system. Disabled by default.
- **Authorized:** Authorize EV driver to start a transaction with this RFID card. Only used for assigned authentication group with **Authorize only the known RFID cards** authentication strategy. Unauthorized by default.
- **Name:** Associate a name to a RFID card.
- **Comments:** Associate a comment to a RFID card.
- **Authentication group:** Assign a RFID card to one or more authentication groups (see [chapter 2.9.1.2](#))

3.11.2.2 Import/Export RFID card

RFID cards list can be exported or imported from web interface. The file format supported by EcoStruxure EV Charging Expert is a CSV file with 4 columns:

- **id_tag:** String type, that corresponds to RFID card information.
- **is_blocked:** Integer type (only 0 and 1 value accepted), that corresponds to authorize (0) or not (1).
- **vip_level:** Integer type (only 0 and 1 value accepted), that corresponds to VIP activation (1) or VIP deactivation (0). A VIP badge gets priority on power allocation before the other charging stations.
- **name:** String type, that correspond to the name associated to the RFID card.
- **comments:** String type, that corresponds to comment associate to RFID card.

CSV file example:

```
id_tag;is_blocked;vip_level;name;comments
E6716CW6514DA;0;0;Name A;Card A
E6654ASXF651G;0;1; Name B;Card A
```

NOTICE**IMPOSSIBLE TO IMPORT RFID CARD LIST FROM ECOSTRUXURE EV CHARGING VERSION BELLOW 6.0.0.**

Export csv file from previous EcoStruxure EV Charging Expert version change the format to respect new format and import RFID card list.

Failure to follow these instructions can result in an impossibility recovery RFID card list.

The maximum of RFID card is 10000.

3.12 Certificates

Access by Admin tab → Configuration → Certificates

3.12.1 Manage Certificates

The screenshot shows the 'Manage Certificates' page in the EcoStruxure EV Charging Expert interface. The page is titled 'Certificates' and includes a sub-header 'Manage Certificates' and 'OCPP & Webserver certificates'. The main content is a table of certificates with the following columns: Id, Name, Subject, and Expires on. Each row has a checkbox on the left and a 'built-in' button on the right. The table contains 8 rows of certificates.

Id	Name	Subject	Expires on
1	Amazon_Root_CA_1	C = US, O = Amazon, CN = Amazon Root CA 1	17/01/2038
2	GlobalSign_Root_CA	C = BE, O = GlobalSign nv-sa, OU = Root CA, C...	28/01/2028
3	QuoVadis_Root_CA_1_G3	C = BM, O = QuoVadis Limited, CN = QuoVadis ...	12/01/2042
4	CFCA_EV_ROOT	C = CN, O = China Financial Certification Autho...	31/12/2029
5	DigiCert_Global_Root_CA	C = US, O = DigiCert Inc, OU = www.digicert.co...	10/11/2031
6	DigiCert_Global_Root_G2	C = US, O = DigiCert Inc, OU = www.digicert.co...	15/01/2038
7	Entrust_Root_Certification_Authority_-_EC1	C = US, O = "Entrust, Inc.", OU = See www.entr...	18/12/2037
8	COMODO_RSA_Certification_Authority	C = GB, ST = Greater Manchester, L = Salford, ...	19/01/2038

Addition or deletion of certificates are allowed in **Manage Certificates** page. For instance, a new remote supervision certificate is uploaded in this bank of certificates to perform a WebSocket secure connection.

3.12.2 Device certificates

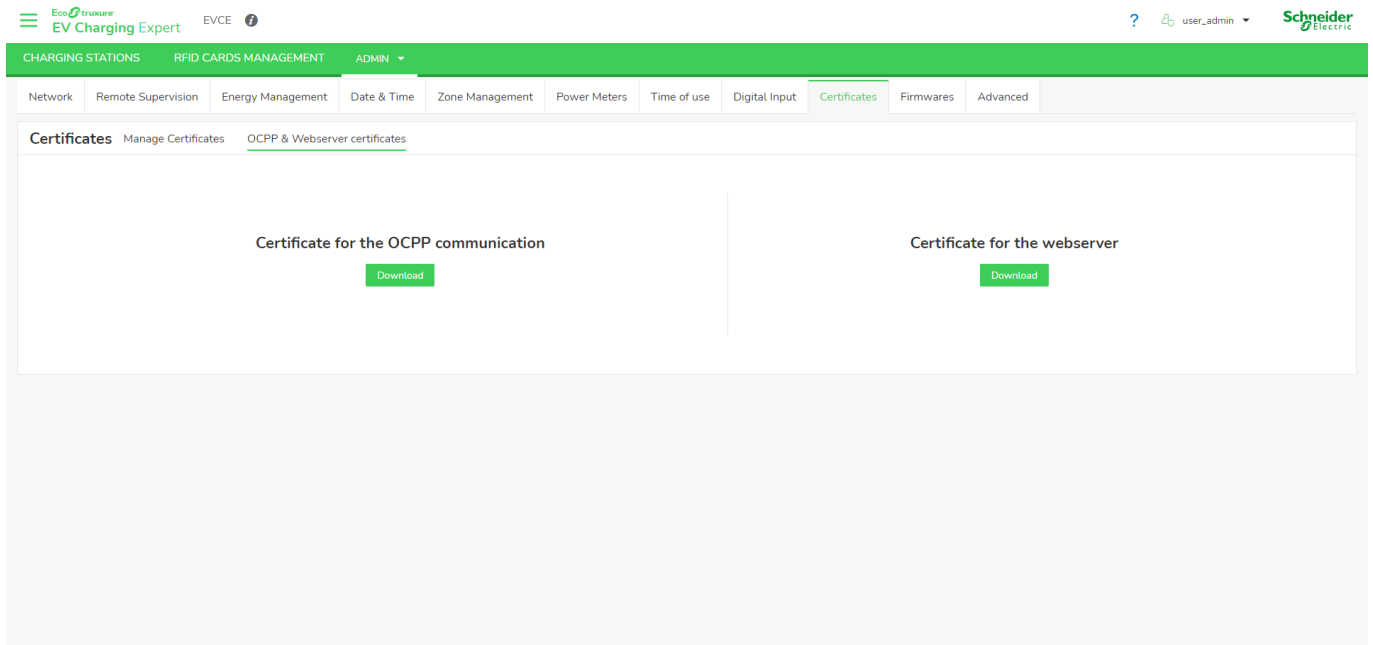

OCPP & Webserver certificates page provides EcoStruxure EV Charging Expert certificates to establish a secure communication between device and charging stations:

- **OCPP certificate:** This certificate is uploaded in the charging station to generate a WebSocket secure connection and manage charging station with OCPP security profiles 1 & 2.
- **Webserver certificate:** This certificate is uploaded in the charging station to establish a HTTPs connection and perform firmware update or get maintenance report in EcoStruxure EV Charging Expert.

3.13 Charging station firmware

Access by Admin tab → Configuration → Firmware

3.13.1 Manage charging station firmware

To update a charging station through EcoStruxure EV Charging Expert, it is required first to add its firmware file in local storage:

- Click on the **Add** button
- Add a firmware version
- Select the charging station model
- Choose the firmware file on your computer
- **Confirm** to start uploading the file into EcoStruxure EV Charging Expert.

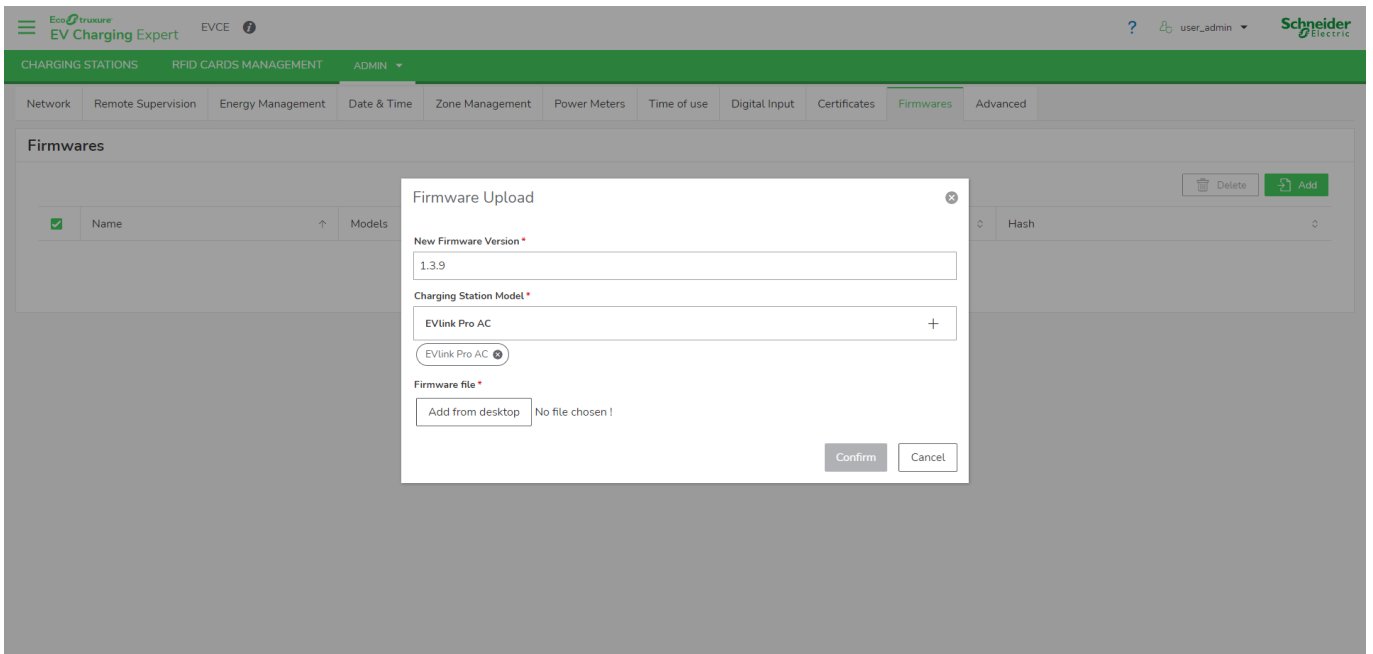

Upload progression is displayed as percentage. At the end of the upload, firmware status is displayed as **Available** (Ready for a firmware upgrade operation) or **Upload error** (impossible to upload the firmware file).

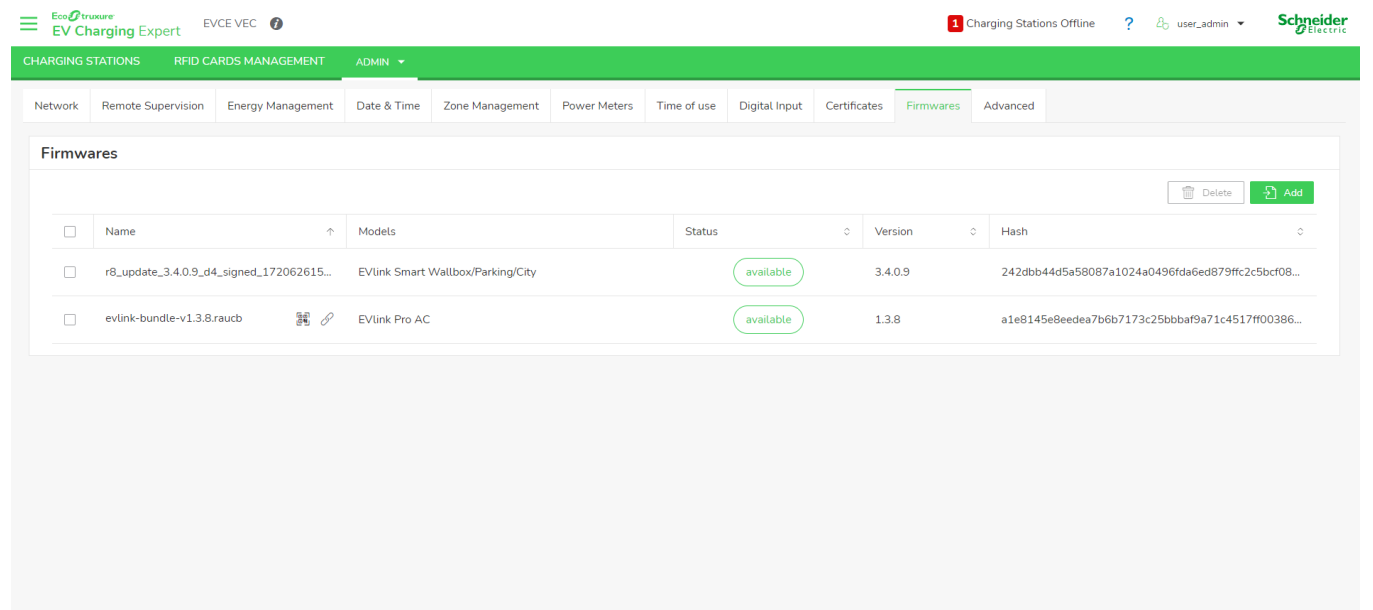



EcoStruxure EV Charging Expert doesn't accept more than one firmware per charging station model. There cannot be more than 6 firmware files at a time.

3.13.2 Internal HTTP server

EcoStruxure EV Charging Expert includes an internal HTTP server, allowing locally connected charging stations to be updated directly from an application or a monitoring system by copying the server URL link.

The URL link is available on firmware station management page and there are two options to get the URL link:

- QR code: 
- Copy/Past: 

It is also possible to manage HTTP unsecure server, see [chapter 3.14](#).

3.13.3 Perform charging station update

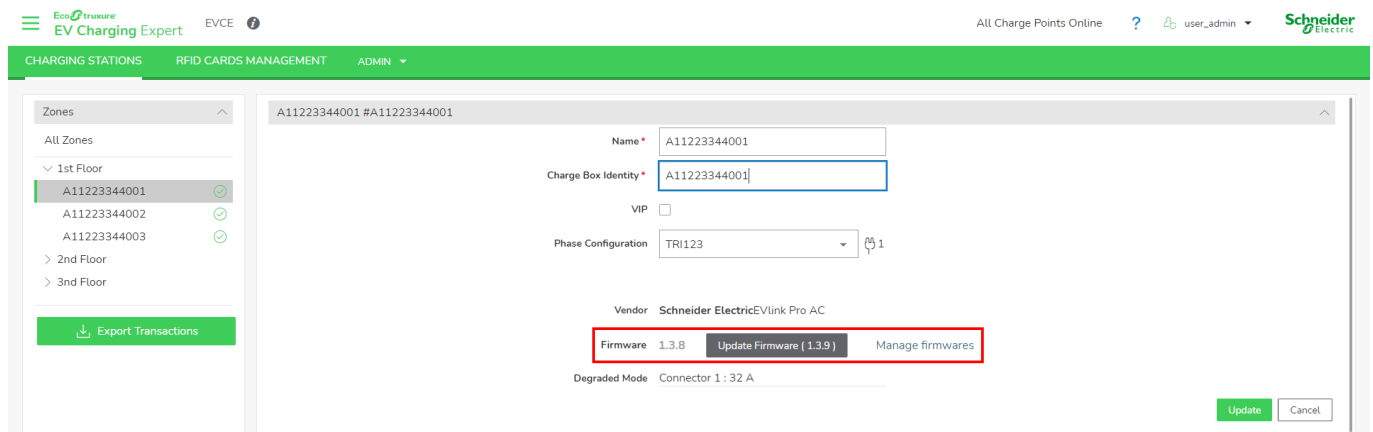

The screenshot displays the EcoStruxure EV Charging Expert interface. The top navigation bar includes 'CHARGING STATIONS', 'RFID CARDS MANAGEMENT', and 'ADMIN'. The left sidebar shows a 'Zones' menu with '1st Floor' expanded, listing three stations: A11223344001 (selected), A11223344002, and A11223344003. The main content area shows the configuration for station A11223344001. Fields include 'Name' (A11223344001), 'Charge Box Identity' (A11223344001), 'VIP' (unchecked), and 'Phase Configuration' (TRI123). The 'Vendor' is 'Schneider ElectricEVlink Pro AC'. The 'Firmware' section shows '1.3.8' and a highlighted 'Update Firmware (1.3.9)' button, along with a 'Manage firmwares' link. The 'Degraded Mode' is 'Connector 1 : 32 A'. 'Update' and 'Cancel' buttons are at the bottom right.

When a new firmware version is available into EcoStruxure EV Charging Expert, **Update Firmware** button appears. The charging station can be upgraded to this new suggested version only when there is no transaction in progress.

3.14 Advanced configuration

Access by Admin tab → Configuration → Advanced

The screenshot displays the 'Advanced Configuration' interface. At the top, there is a navigation bar with 'ADMIN' selected. Below it, a sub-menu shows 'Advanced' as the active tab. The main content area is titled 'Advanced Configuration' and includes the following settings:

- Enable SSH:** A toggle switch is currently set to 'ON'.
- HTTPS only:** A toggle switch is currently set to 'OFF', accompanied by a help icon.
- Webservice Configuration:** A link labeled 'Swagger API Documentation' is provided.

A green 'Save' button is positioned at the bottom left of the configuration panel.

In this section are configured EcoStruxure EV Charging Expert advanced parameters related to SSH and access to API. API documentation is accessible as Swagger format to describe all possible commands to integrate EV charging infrastructure into an Energy or Building Management Software.

With **HTTPS only**, it is possible to deactivate HTTP server and manage EcoStruxure EV Charging Expert communication with charging station only in secure way.

For cybersecurity reasons, it is recommended to activate SSH only for maintenance purpose. Please contact Schneider Electric support prior to use this option.

3.15 User management

Access by the Admin tab → Users management

3.15.1 User management landing page

Username	Role	Date of Creation	Last Access
user_admin	admin	15/07/2024, 15:38:01	17/07/2024, 11:25:52
user_operator	operator	15/07/2024, 15:38:01	--

During the wizard, two default users are created (see [chapter 2.2](#)):

- Admin user
- Operator user

3.15.2 User addition

To create a user, click on **Add User** and fill below information:

- **New User Role:**
 - Admin: Manager of the installation. This role has access to all settings.
 - EBMS (Building Management System): Role used for Energy of Building Management Softwares, capable of managing charging stations directly through the REST API of EcoStruxure EV Charging Expert.
 - Operator: Role used for dashboard operations.
- **New Username**
- **New User Password / Confirm Password:** The password must be at least 12 characters long and must contain lowercase characters, uppercase characters, numbers, special characters (@!%?&)

3.15.3 Change the user password

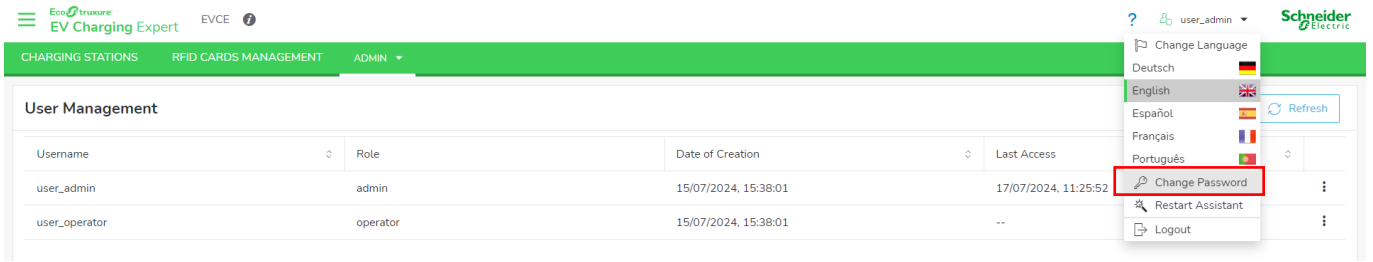

A user can change webpage password anytime from personal menu.

3.15.4 Edit a user

Users can be edited from the user administration webpage, only accessible to administrators.

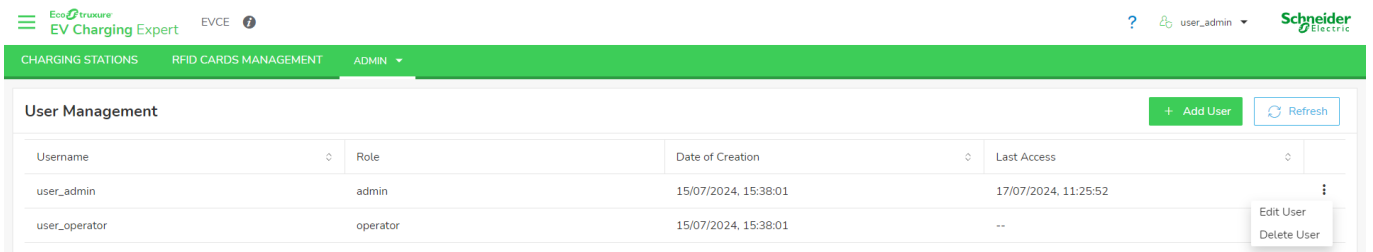

3.16 Maintenance

3.16.1 Device logs

Access by the Admin tab → Logs

Date	Device	Type	Sub Type	Message
18/07/2024, 15:33:13	EVCE	Security	connection_success	Logon
18/07/2024, 15:31:04	EVCE	Security	connection_failure	Unknown
18/07/2024, 15:31:04	EVCE	Security	connection_failure	Unknown
18/07/2024, 15:31:04	EVCE	Security	connection_failure	Unknown
18/07/2024, 15:31:04	EVCE	Security	connection_failure	Unknown
18/07/2024, 12:00:09	EVCE	Time of use	Status	Period : P
18/07/2024, 09:44:07	EVCE	Stations maintenance	Restarting periodic generati...	86400s (
18/07/2024, 09:43:28	EVCE	Security	connection_success	Logon
18/07/2024, 09:43:21	EVCE	Security	connection_failure	Unknown
18/07/2024, 09:43:21	EVCE	Security	connection_failure	Unknown user

In log tab, all information related to security events, communication and load balancing are available. The logs can be filtered and exported according to charging stations, zones and log types.

EV Charging Expert can store up to 100,000 entries.

3.16.2 Device maintenance report

Access by the Admin tab → Device Report

EcoStruxure EV Charging Expert diagnostic is a file containing all information about the device (identification, firmware version, logs etc.).

3.16.3 Charging station maintenance report

Access by the Admin tab → Station reports

The screenshot shows the 'Downloading Charging Stations Report' interface. At the top, there is a navigation bar with 'CHARGING STATIONS', 'RFID CARDS MANAGEMENT', and 'ADMIN' tabs. The main content area features a table with the following columns: Station Name, Date, Type, and Zone. The table lists reports for 'Borne 1.1' (9 reports selected), 'Borne 1.2' (0/8 reports selected), 'Borne 10.1' (0/7 reports selected), 'Borne 10.2' (0/7 reports selected), and 'Borne 11.1' (0/7 reports selected). A 'Download' button is located in the top right corner of the report area.

Station Name	Date	Type	Zone
Borne 1.1 (0/9 reports selected)			
Borne 1.1	03/07/2024, 15:07:18	manual	TD_VE
Borne 1.1	03/07/2024, 15:10:53	manual	TD_VE
Borne 1.1	12/07/2024, 11:08:15	periodic	TD_VE
Borne 1.1	13/07/2024, 11:08:15	periodic	TD_VE
Borne 1.1	14/07/2024, 11:08:16	periodic	TD_VE
Borne 1.1	15/07/2024, 11:08:17	periodic	TD_VE
Borne 1.1	16/07/2024, 11:08:17	periodic	TD_VE
Borne 1.1	17/07/2024, 11:08:18	periodic	TD_VE
Borne 1.1	18/07/2024, 11:08:14	periodic	TD_VE
Borne 1.2 (0/8 reports selected)			
Borne 10.1 (0/7 reports selected)			
Borne 10.2 (0/7 reports selected)			
Borne 11.1 (0/7 reports selected)			

For each charging station with maintenance reports generation feature, EcoStruxure EV Charging Expert saves periodically a device report. From 5 to 10 periodic / manual reports can be stored. To generate a report manually, see [chapter 3.2.2](#).

To download device report, please select device reports and click on **Download**.

3.17 EV Charging Expert Firmware update

Access by hamburger menu → Firmware Update

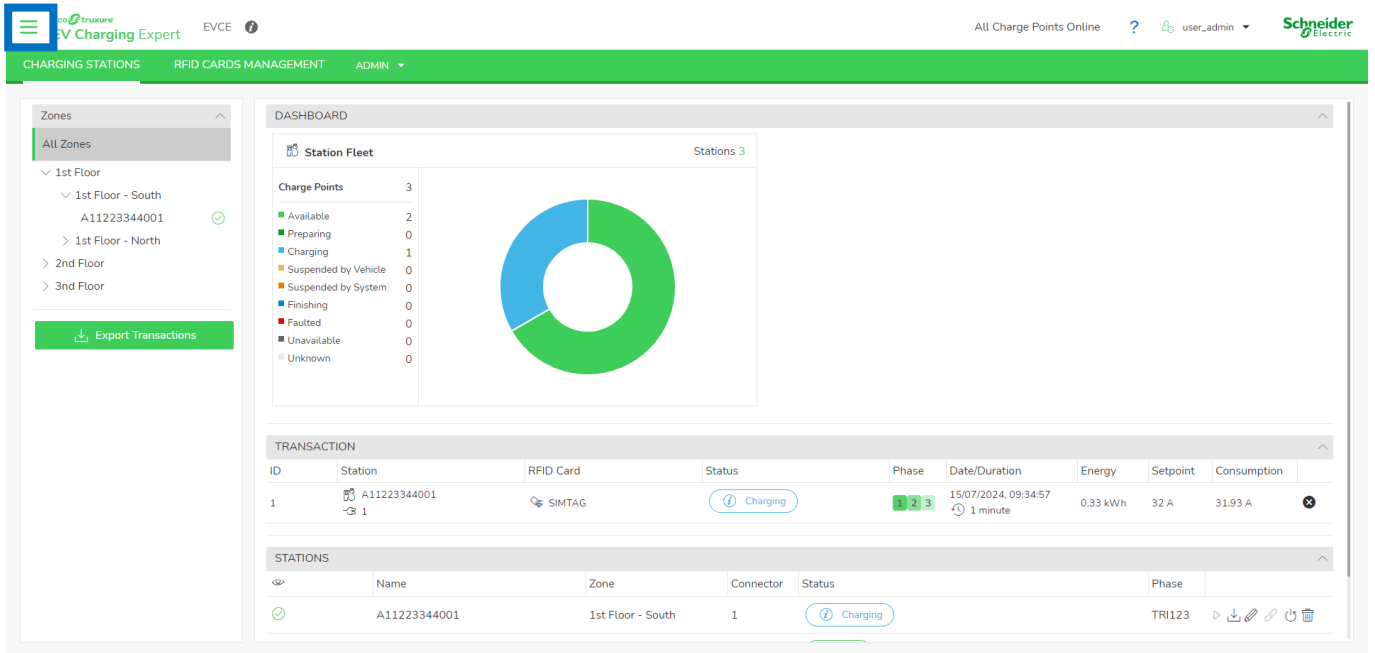

To upgrade EcoStruxure EV Charging Expert, select bundle from desktop. An update page appears while new version gets installed. Around one minute after the upgrade start, an automatic reboot happens to apply the new firmware.

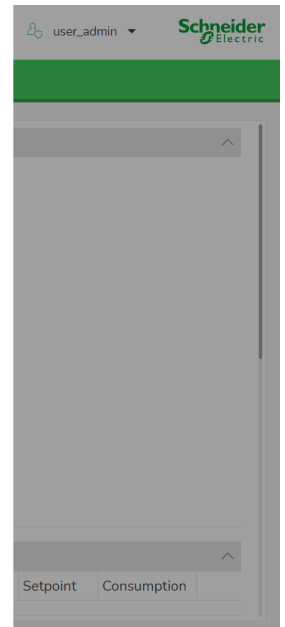
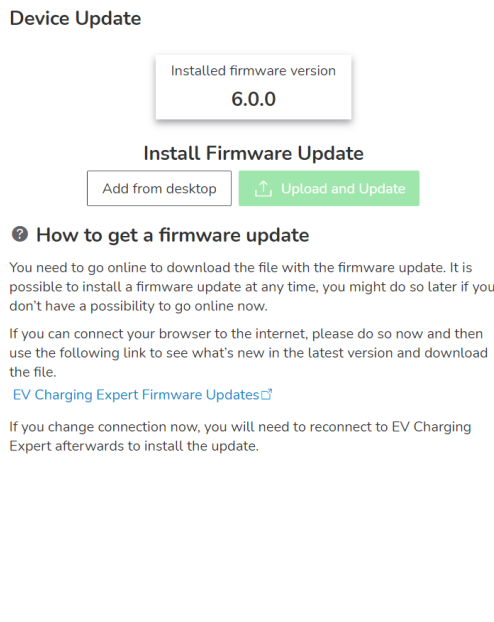

3.18 License upgrade

EcoStruxure EV Charging Expert license can be upgraded (for example, from a 15 charging stations reference, to a 50 charging stations license). Please contact your Schneider Electric commercial partner.

Access by hamburger menu → Firmware Update

EcoStruxure EV Charging Expert serial number is required to get an upgrade package. All information is present on licence page and should be provided to Schneider Electric.

✕ Menu

- Licence Upgrade >
- Back To Factory Settings >
- About >

User licence

Current licence

Reference Name: HMIBSCEA53D1E2L
Serial Number: S/N1234568

150
Stations

20
Zones

4
Zone levels

Local Production

Local CSMS

Add-on licences

Licence request

To request a new licence, please send an email to the address below. A new file will be provided by Schneider Electric support teams to upgrade the licence.

[Request By Email](#)

Upload Licence Key

Add the licence key from your Desktop and click on Upload.

Description	Type	Reference	Validity
EV charge controller, EcoStruxure EV Charging Expert, 150 charging stations, dynamic charge management	base	HMIBSCEA53D1E2L	29/07/2124 ▼

Life Is On | **Schneider Electric**

www.se.com

Request By Email link will automatically open your email software and prepare a message with all required product information.

A license upgrade can:

- Increase the number of charging stations in EVCE.
- Add zones.
- Add features: local production, local CSMS.
- Add new models of charging stations.

3.19 Reboot and back to factory settings

Access by the Admin tab → Restart or Factory Reset

3.19.1 Reboot and back to factory settings from the webserver

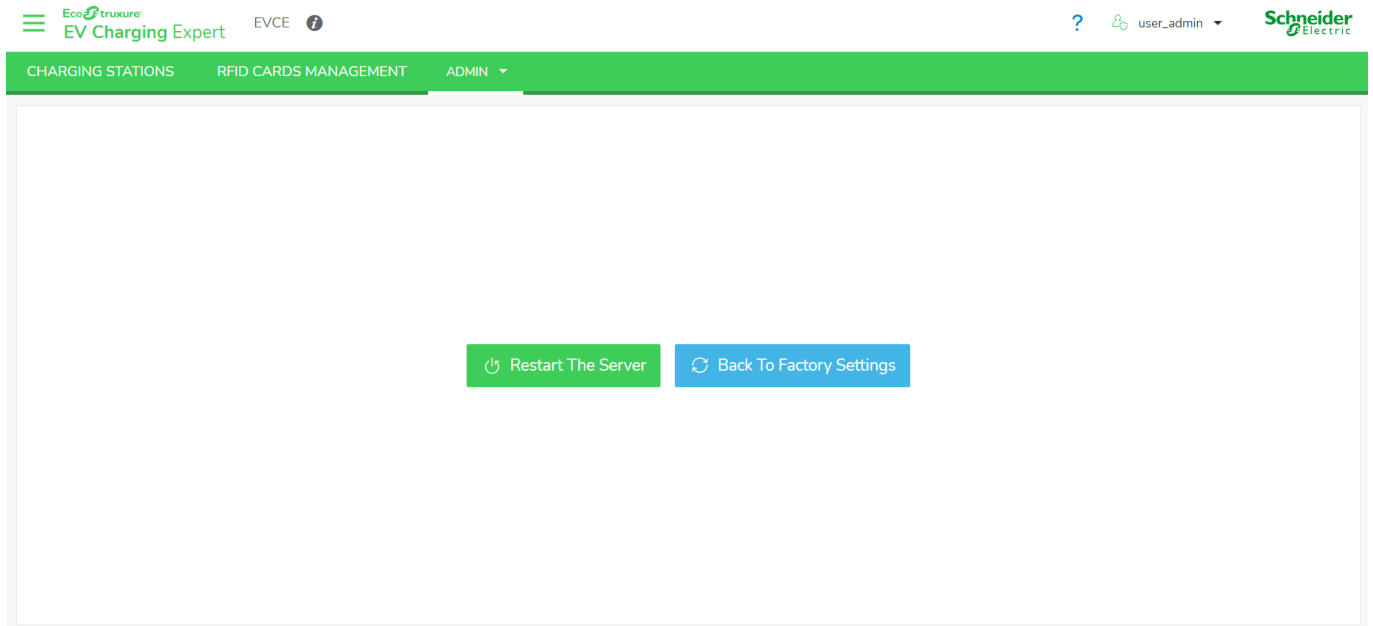

When **Restart The Server** is selected, the EcoStruxure EV Charging Expert reboots. During the reboot, the communication with supervision and charging stations is lost.

When **Back To Factory Settings** is selected, all information stored into the EcoStruxure EV Charging Expert is erased. This action is irreversible.

3.19.2 Hardware back to factory settings

This procedure describes the steps to flash an EcoStruxure EV Charging Expert using industrial SD Card. This is the only procedure to run a complete reset of the product to version 6 and more.

3.19.2.1 Prerequisites

The following material is required:

- An SD Card of at least 8 GB (can be a microSD card with an SD card adapter)
- A Windows computer with an SD Card reader and administrative rights

3.19.2.2 SD Card preparation

The SD card / SD card adapter side latch should be “Unlocked” position:

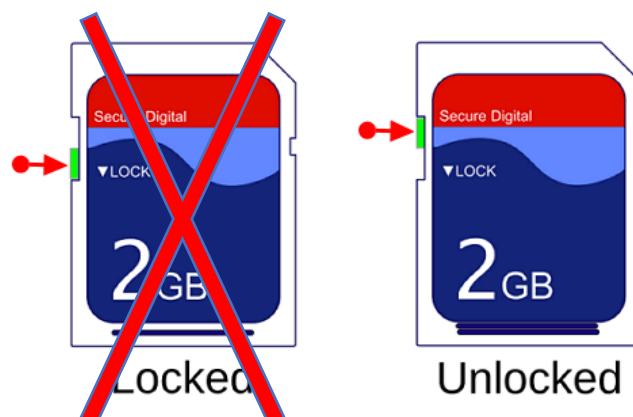

Plug the SD Card to the Windows computer using an internal SD card reader or an external USB SD card reader. Download Balena Etcher software from <https://etcher.balena.io/>

Install the downloaded software on your computer (administrative rights may be required). Launch the Etcher software:

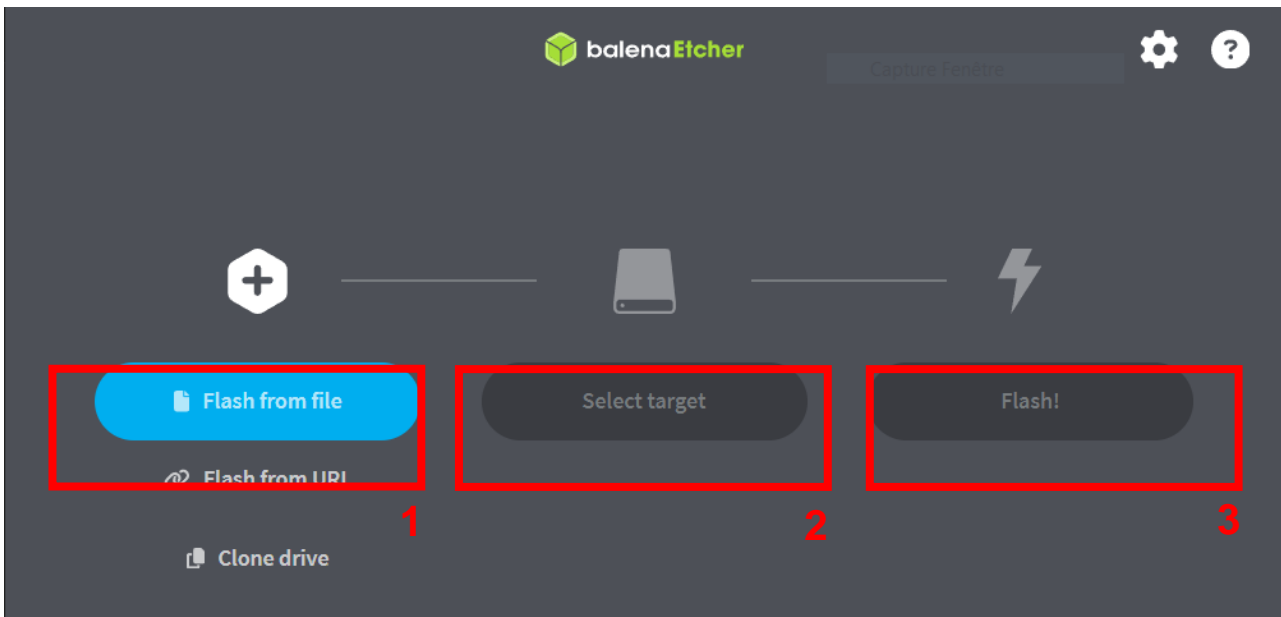

1. Download the EcoStruxure EV Charging Expert SD card back to factory image on se.com, click on “Flash from file” and select the image.
2. Click on “Select target” and select your SD card.
3. Click on “Flash”. The SD card content will be erased and replaced by the EcoStruxure EV Charging Expert back to factory image. Wait for the Decompressing, Flashing and Verifying process to end with success.

At the end you should get the following message:

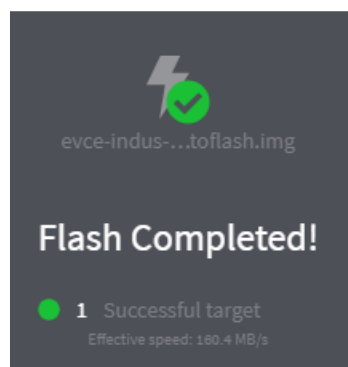

If you have an error, try again by using another SD card or another SD card reader.

3.19.2.3 Flashing the EcoStruxure EV Charging Expert

1. Unplug the device from power source.
2. Insert the prepared SD Card into the EcoStruxure EV Charging SD card slot (see [chapter 1.1.1.6](#)).
3. Plug the device from power source.
4. Led start blinking quickly.
5. At the end of the installation, led blinks slowly.
6. Don't forget to remove the SD Card and restart your device.

3.20 Save and Restore

3.20.1 Save configuration

Access by the Admin tab → Save

The EcoStruxure EV Charging Expert allows to save a backup of the current system configuration. This configuration can be imported later to automatically restore a lost configuration.

Configuration export content:

- Admin and user profiles credentials
- Charging stations configuration
- Zones configuration
- Power meters configuration
- Network configuration
- Authentication strategies
- List of RFID cards
- Authentication groups

When clicking **Save** button, a password and comment are required to generate the backup file. To guarantee the security of your information, exported file is encrypted and signed. It is strongly recommended to save the exported file in a safe repository.

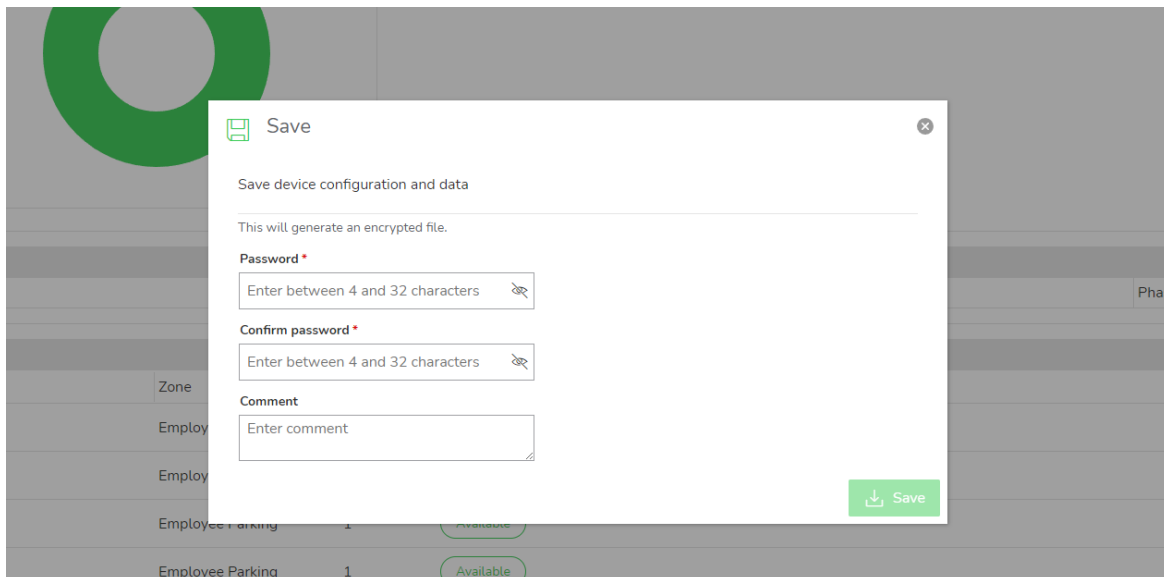

3.20.2 Restore configuration

Restore pop-up allows to recover a configuration from a previous configuration export. Only configuration file from version 6.0.0 or upper are compatible. This requires configuration file password to be installed.

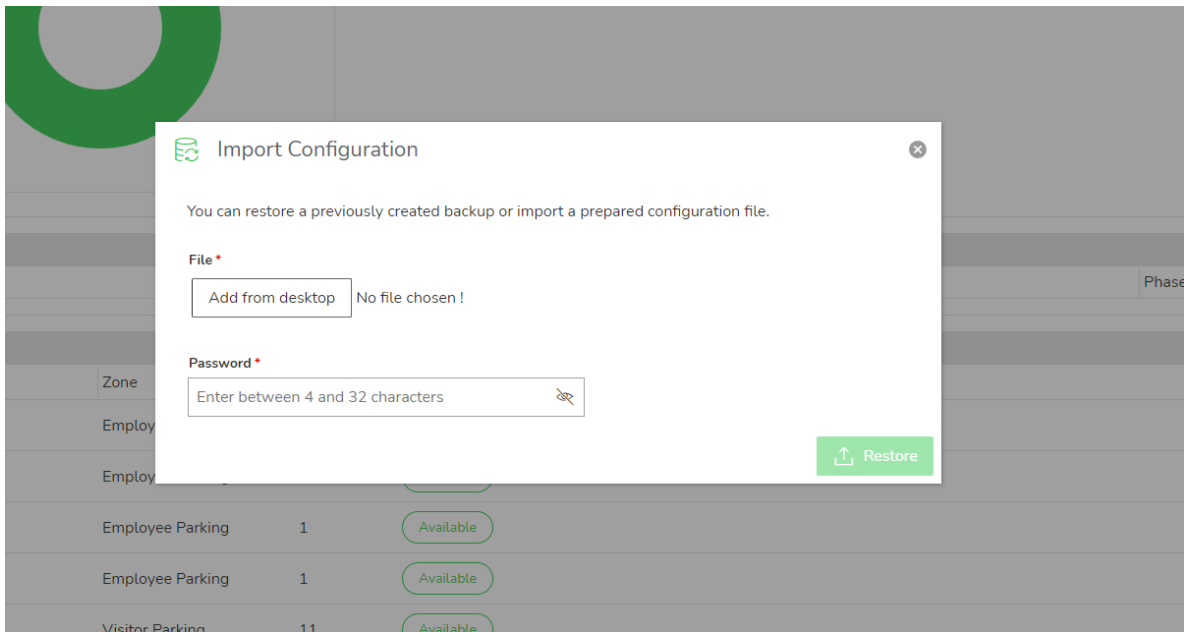

Chapter 4. REGULATORY INFORMATION



RCM certification

Schneider Electric Industries SAS

35, rue Joseph Monier
CS 30323
92506 Rueil Malmaison Cedex
France

www.se.com

DOCA0163EN© 2020 Schneider Electric. All rights reserved