

EcoStruxure™ EV Charging Expert

User Guide

04/2026

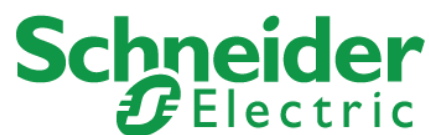

Legal information

The information provided in this document contains general descriptions, technical characteristics and/or recommendations related to products/solutions.

This document is not intended as a substitute for a detailed study or operational and site-specific development or schematic plan. It is not to be used for determining suitability or reliability of the products/solutions for specific user applications. It is the duty of any such user to perform or have any professional expert of its choice (integrator, specifier or the like) perform the appropriate and comprehensive risk analysis, evaluation and testing of the products/solutions with respect to the relevant specific application or use thereof.

The Schneider Electric brand and any trademarks of Schneider Electric SE and its subsidiaries referred to in this document are the property of Schneider Electric SE or its subsidiaries. All other brands may be trademarks of their respective owner.

This document and its content are protected under applicable copyright laws and provided for informative use only. No part of this document may be reproduced or transmitted in any form or by any means (electronic, mechanical, photocopying, recording, or otherwise), for any purpose, without the prior written permission of Schneider Electric.

Schneider Electric does not grant any right or license for commercial use of the document or its content, except for a non-exclusive and personal license to consult it on an "as is" basis.

Schneider Electric reserves the right to make changes or updates with respect to or in the content of this document or the format thereof, at any time without notice.

To the extent permitted by applicable law, no responsibility or liability is assumed by Schneider Electric and its subsidiaries for any errors or omissions in the informational content of this document, as well as any non-intended use or misuse of the content thereof.

About this guide

Document scope

The purpose of this guide is to provide installers, maintenance personnel and users with the technical information necessary to install, commission and use the EcoStruxure EV Charging Expert.

Introduction

- EcoStruxure EV Charging Expert main features:
 - allocate a current setpoint to the charging stations in operation
 - see in real time the status of the charging stations through the dashboard
 - manage user authentication for charging authorization
 - get the charging sessions history and data from the charging stations in the network
- EcoStruxure EV Charging Expert is compatible with remote supervision from a Charge Point Operator in OCPP 1.6 Json.
- EcoStruxure EV Charging Expert allows two access profiles:
 - **Admin:** Access to all configuration parameters and features, dashboard operation and RFID cards management.
 - **EBMS (Building Management System):** Role used for Energy of Building Management Softwares, capable of managing charging stations directly through the REST API of EcoStruxure EV Charging Expert.

Related documents

Title of documentation	Reference number
eMobility Infrastructure Design guide for building applications	EVSOL1DG001EN
Instructions sheet for Acti9 Smartlink SI D gateway A9XMWA20 (English, Dutch, French, German, Italian, Portuguese, Spanish, Chinese, Russian)	NVE60007
Instructions sheet for power meter METSEPM5320 (English, Dutch, French, German, Italian, Portuguese, Spanish, Chinese, Russian)	HRB69887
Instructions sheet for power meter A9MEM3250 (English, Dutch, French, German, Italian, Portuguese, Spanish, Chinese, Russian)	NHA15795
Instructions sheet for Enerlin'X IFE gateway LV434002 (English, French)	DOCA0084
Instructions sheet Enerlin'X EIFE communication module LV851001 (English, French)	DOCA0106
Installation guide for EcoStruxure EV Charging Expert (English)	EIO0000005096
EcoStruxure EV Charging Expert - Rest API	EVINBEMS
eMobility Infrastructure – Commissioning Guide	EVSOLCG001EN

You can download these technical publications and other technical information from our website at <https://www.se/en/download>

Trademarks

QR Code is a registered trademark of DENSO WAVE INCORPORATED in Japan and other countries.

Safety information

Important information

Read these instructions carefully, and look at the equipment to become familiar with the device before trying to install, operate, service, or maintain it. The following special messages may appear throughout this documentation or on the equipment to warn of potential hazards or to call attention to information that clarifies or simplifies a procedure.



The addition of this symbol to a “Danger” or “Warning” safety label indicates that an electrical hazard exists which will result in personal injury if the instructions are not followed.



This is the safety alert symbol. It is used to alert you to potential personal injury hazards. Obey all safety messages that follow this symbol to avoid possible injury or death.

DANGER

DANGER indicates a hazardous situation which, if not avoided, **will result in** death or serious injury.

WARNING

WARNING indicates a hazardous situation which, if not avoided, **could result in** death or serious injury.

CAUTION

CAUTION indicates a hazardous situation which, if not avoided, **could result in** minor or moderate injury.

NOTICE

NOTICE is used to address practices not related to physical injury.

PLEASE NOTE

Electrical equipment should be installed, operated, serviced, and maintained only by qualified personnel. No responsibility is assumed by Schneider Electric for any consequences arising out of the use of this material.

A qualified person is one who has skills and knowledge related to the construction and operation of electrical equipment and its installation and has received safety training to recognize and avoid the hazards involved.

Table of contents

Chapter 1. SYSTEM ENVIRONMENT	8
1.1 Glossary	9
1.2 EcoStruxure EV Charging Expert.....	9
1.2.1 Overview	9
1.3 EcoStruxure EV Charging Expert characteristics	18
1.3.1 General characteristics	18
1.3.2 Environmental characteristics.....	18
1.3.3 Power supply characteristics	19
1.3.4 Communication modules	20
1.4 Set up of EcoStruxure EV Charging Expert system environment.....	21
1.4.1 EcoStruxure EV Charging Expert installation	21
1.5 Electrical zone definition	23
Chapter 2. EcoStruxure EV Charging Expert COMMISSIONING	26
2.1 Starting with EcoStruxure EV Charging Expert.....	26
2.1.1 Computer specification	26
2.1.2 Computer configuration	26
2.1.3 Login to the EcoStruxure EV Charging Expert	26
2.2 Credentials configuration	29
2.3 Wizard steps.....	29
2.3.1 Network.....	29
2.3.2 Remote supervision	29
2.3.3 Date & Time.....	29
2.3.4 Energy management	29
2.3.5 Stations configuration	30
2.3.6 Power meter configuration.....	30
2.3.7 Zones configuration	30
2.3.8 Station assignment	30
2.3.9 Authentication group.....	30
2.3.10 RFID Cards	30
Chapter 3. OPERATION INTERFACE	31
3.1 Menu and status bar	32
3.2 Dashboard.....	33
3.2.1 Global view	33
3.2.2 Zone view	34
3.2.3 Transaction view.....	35
3.2.4 Station view	35
3.3 Network configuration	37
3.3.1 EcoStruxure EV Charging Expert name	37
3.3.2 Network configuration	37
3.3.3 Proxy configuration	38
3.3.4 DHCP server configuration	38
3.4 Remote supervision configuration.....	39
3.4.1 Supervision selection.....	39
3.4.2 Unique supervision	39
3.4.3 Multiple supervision	40
3.5 Energy management configuration	42
3.5.1 Load shedding configuration	42
3.5.2 Consumption optimization configuration.....	42

3.5.3	Allow Suspended by System	42
3.5.4	Local production management	43
3.6	Charging stations commissioning.....	45
3.6.1	Prerequisites	45
3.6.2	Charging station installation page.....	45
3.6.3	Charging station status	46
3.6.4	Charging station configuration	47
3.6.5	Manual charging station configuration	47
3.7	Power meter configuration	50
3.7.1	Prerequisites	50
3.7.2	Manage Power Meters.....	50
3.7.3	Define a new power meter model	51
3.8	Zone configuration.....	52
3.8.1	Prerequisites	52
3.8.2	Zone configuration	52
3.8.3	Zone creation	52
3.8.4	Degraded Mode	53
3.8.5	Charging station electrical zone assignation	53
3.9	Time Of Use	55
3.9.1	Definition	55
3.9.2	Prerequisites	55
3.9.3	Time Of Use configuration tab	55
3.9.4	Zone configuration tab	56
3.9.5	Summary tab.....	56
3.10	Digital Inputs.....	57
3.10.1	Definition	57
3.10.2	Commissioning	57
3.10.3	Electrical connection	58
3.11	Local authentication management	59
3.11.1	Authentication group	59
3.11.2	RFID cards.....	61
3.12	Certificates.....	62
3.12.1	Manage Certificates	62
3.12.2	Device certificates.....	63
3.13	Charging station firmware	64
3.13.1	Manage charging station firmware.....	64
3.13.2	Internal HTTP server.....	65
3.13.3	Perform charging station update.....	65
3.14	Advanced configuration.....	66
3.15	User management.....	67
3.15.1	User management landing page.....	67
3.15.2	User addition.....	67
3.15.3	Change the user password.....	68
3.15.4	Edit a user.....	68
3.16	Maintenance.....	69
3.16.1	Device logs	69
3.16.2	Device maintenance report.....	69
3.16.3	Charging station maintenance report.....	70
3.17	EV Charging Expert Firmware update	71
3.18	License upgrade.....	72
3.19	Reboot and back to factory settings	73

3.19.1	Reboot and back to factory settings from the webserver	73
3.19.2	Hardware back to factory settings	74
3.20	Save and Restore	76
3.20.1	Save configuration	76
3.20.2	Restore configuration.....	76
Chapter 4.	REGULATORY INFORMATION	77

Chapter 1.

SYSTEM ENVIRONMENT

1.1 Glossary

- **EV** : Electrical Vehicle
- **AC**: Alternate Current
- **DC**: Direct Current
- **VIP**: Very Important Person
- **RFID**: Radio Frequency Identification
- **CDR**: Charging Data Record
- **HMI**: Human Machine Interface
- **OCPP**: Open Charge Point Protocol
- **DHCP**: Dynamic Host Configuration Protocol

1.2 EcoStruxure EV Charging Expert

1.2.1 Overview

EcoStruxure EV Charging Expert (EVCE) is the necessary tool for optimizing the electricity usage associated with the Electrical Vehicle charging needs of a commercial building or a Multi Family Home.

EcoStruxure EV Charging Expert main features:

- Allocate a current setpoint to the charging stations in operation.
- See in real time the status of the charging stations through the dashboard.
- Manage user authentication for charging authorization.
- Get the charging sessions history and data from the charging stations in the network.
- Compatibility with remote supervision from a Charge Point Operator in OCPP 1.6 Json.
- EcoStruxure EV Charging Expert allows two access profiles:
 - **Admin**: Access to all configuration parameters and features, dashboard operation and RFID cards management.
 - **User**: Dashboard operation and RFID cards management.

1.2.1.1 Power management functions

For a specific electrical infrastructure, the maximum power available for EV charging is distributed among the connected vehicles.

An electric vehicle needs a minimum setpoint to accept charging and, if this minimum is not available, the charge will temporarily be suspended for this particular charging point.

The Load Management System allows the admin profile to choose between two thresholds (floor values) for AC charging:

- 8A by default for single phase charging and 14A by default for three-phase charging (based on EV/ZE ready)
- 6A by default for both single phase and three-phase (based on IEC 61851)

When a new vehicle connects and there is not enough available power, the system will suspend the charging of another vehicle to allow the new vehicle to charge.

Two options of charging prioritization are available during the configuration of the load management system:

- Energy:

The system suspends the charging of vehicles which have already consumed the highest amount of energy. This option is set by default.

- Duration:

The system suspends the charging of vehicles with the longest charging time.

In both cases, the EcoStruxure EV Charging Expert reviews these values every 15 minutes and updates charging priorities accordingly.

EcoStruxure EV Charging Expert can manage VIP information with admin profile:

- VIP RFID: Once authenticated as VIP EV driver, the EV gets maximum available* power no matter the charging station.
Note: VIP RFID card is not available when remote supervision communication is activated
- VIP charging station: The charging station allows any EV to get the maximum available* power.

**The maximum available power for VIP status may be lower than the charging station rating depending on the number of simultaneous VIP charging sessions.*

1.2.1.2 Static and dynamic power management

Static mode

The maximum current setpoint for the whole charging infrastructure is a static value depending on the subscribed power supply and limitations of power distribution. This current is distributed between all connected vehicles to limit the risk of installation tripping.

Consumption profile in static mode:

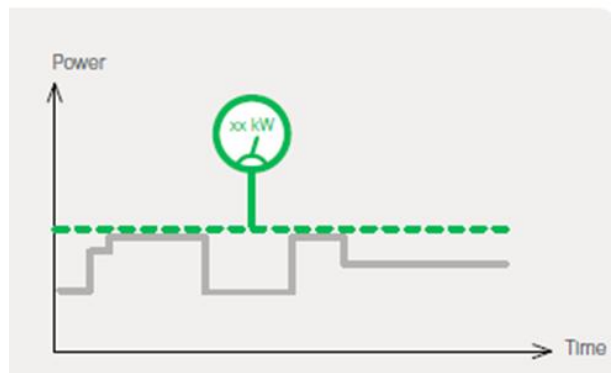

Dynamic mode

The maximum current setpoint for the whole charging infrastructure changes dynamically according to the building consumption while considering the subscribed power supply and/or local production. The remaining available current is distributed between all connected vehicles to limit the risk of installation tripping.

Consumption profile in dynamic mode:

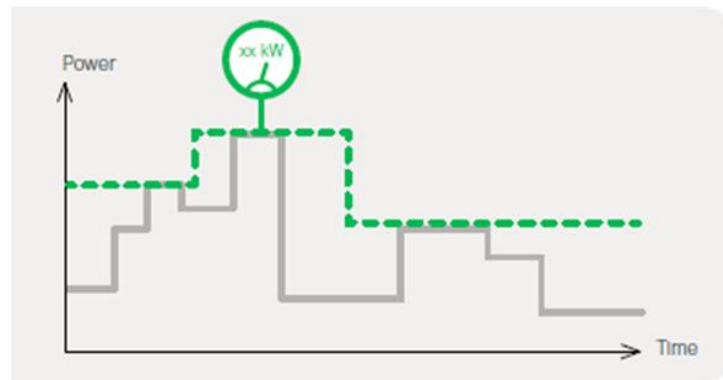

In dynamic mode, the EcoStruxure EV Charging Expert must be connected to power meters measuring the consumption of the building and the charging stations.

1.2.1.3 EcoStruxure EV Charging Expert product range & features

		Load Management License
		HMIBX1A0NEVB100SCP
Capacity	Max number of charging stations	250
Power Management	With a static setpoint	●
	With a dynamic setpoint	●
Multi zone	Max number of zones	20
	Max number of zone levels (Top zone + sub-zones)	4
Advanced	Local production Local authentication Transactions logs	●

1.2.1.4 User profile features

Operate EcoStruxure EV Charging Expert Dashboard

The dashboard displays:

- The status of all charge points (connectors)
- The power consumption per phase

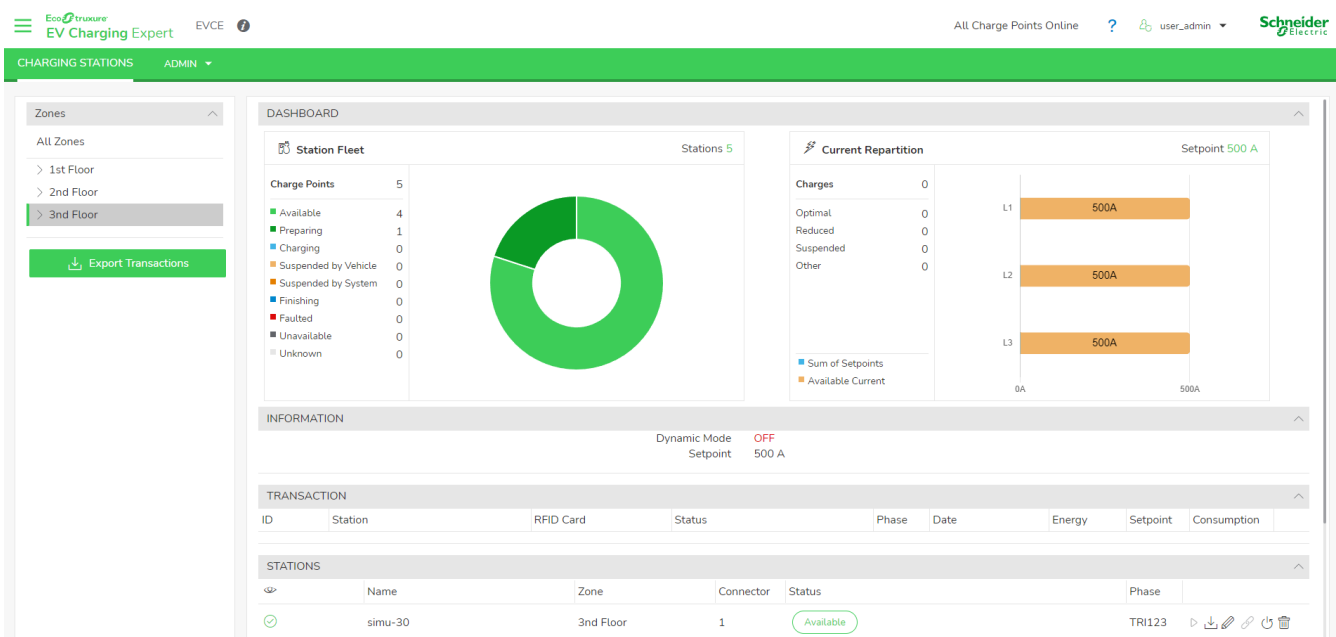

Remote control of charging station and transactions

Below actions are available through “Charging Station” tab:

- Remote start*

- Remote stop*
- Remote force stop*
- Reboot (automatic charging resume)
- Reset (charging stopped)
- Access to maintenance report
- Access to webserver (if feature available for charging station)

**Only available when remote supervision is deactivated*

RFID cards management

When the EcoStruxure EV Charging Expert is in standalone mode (remote supervision deactivated), it is possible to:

1. Create authentication group
2. Configure authentication strategy of each group
3. Allocate RFID cards and stations to these groups

Access through "RFID cards management" from the dashboard. See [chapter 3.11](#)

Export Charging Data Records (CDR)

On the EcoStruxure EV Charging Expert Dashboard, the user can see the active charging sessions.

EcoStruxure EV Charging Expert can register over 1 million transactions data, also called charging data records, in its internal memory. The charging data records can be exported as an external file in CSV format for all the charging stations.

It is possible to select the period before exporting the file.

Access through "Export transactions" from the dashboard. See [chapter 3.2.3](#)

1.2.1.5 Admin profile features

In addition to the user profile features, the admin profile can change the configuration of the charging stations, and upgrade EcoStruxure EV Charging Expert firmware.

EcoStruxure EV Charging Expert commissioning

All parameters are accessible via the admin/configuration page.

The admin profile sets configuration parameters for:

- Network configuration
- Remote supervision
- Energy management
- Date & Time
- Zone management
- Power meters
- Time of use
- Certificates
- Firmwares of charging stations
- Advanced Parameters
- User management
- Logs
- Device report
- Station reports
- Zone/Station configuration

EcoStruxure EV Charging Expert maintenance

The admin profile can:

- Update the EcoStruxure EV Charging Expert firmware
- Get EcoStruxure EV Charging Expert logs
- Operate a “Back to factory”
- Operate a “Save & restore”
- Manage users accounts and passwords
- Download EcoStruxure EV Charging Expert maintenance report
- Download charging station maintenance report
- Access the Wizard that is used for initial commissioning

1.2.1.6 EcoStruxure EV Charging Expert hardware features

Side View

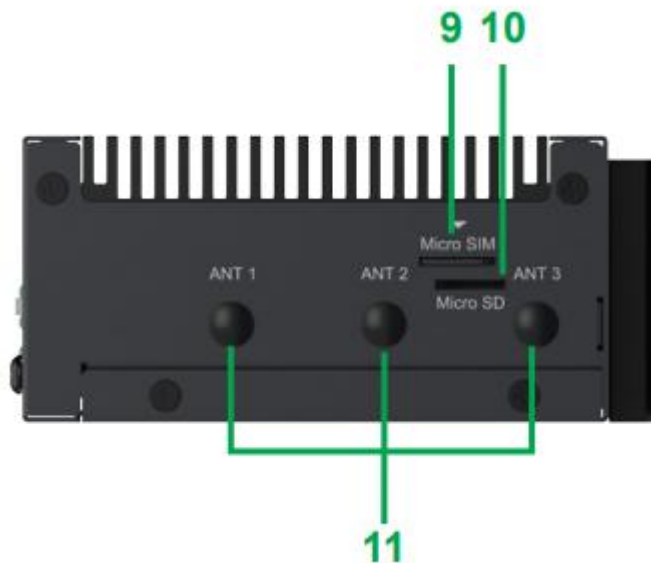

- 9 – SIM Card slot (not used)
- 10 – SD Card slot
- 11 – External Antenna slot (not used)

Rear View

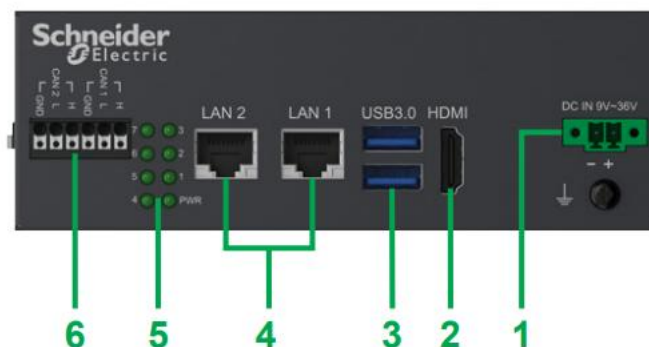

- 1 – DC power connector
 - 2 – HDMI port (**deactivated***)
 - 3 – USB 3.0
 - 4 – LAN ports (10/100/1000 Mb/s)(**LAN 2 is deactivated by default**)
 - 5 – LEDs
 - 6 – CAN ports (**deactivated***)
- * Hardware deactivation improves cybersecurity**

1.2.1.7 EVlink charging stations

Charging station	Supported	Minimal version
EVlink Pro AC Schneider StarCharge Fast 60	Yes	1.6.1
EVlink Pro DC 120/150/180 Schneider StarCharge Fast 180/320	Yes	2.7.02
EVlink Pro DC 60	Yes	2.6.15
EVlink Parking	Yes	3.4.0.10
EVlink Smart WallBox	Yes	3.4.0.10
EVlink City	Yes	3.4.0.10
24kW DC Charger	Yes	V028.803
Schneider Charge Pro	Yes	2.0.3
Bender	No	
WallBee	No	





Latest releases are available on se.com/download.

For previous releases, contact [Schneider Electric Customer Care Center](#).

1.2.1.8 Power meters

Note: power metering is only required when the EcoStruxure EV Charging Expert is used in dynamic mode.

The table below lists few recommended power meters.

Name	Pole description	Input type	Comment
<p>A9MEM3250 (PAS600+ Acti 9 iEM3000)</p> 	<p>1P + N / 3P / 3P + N</p>	<p>External CT: 1 A or 5 A</p> <p>CT: Current Transformer</p>	
<p>METSEPM5320 (PowerLogic PM5000)</p> 	<p>1P + N / 3P / 3P + N</p>		
<p>A9XMWD20 (PowerTag Link + Power Tags)</p> 	<p>1P + N / 3P / 3P + N</p>	<p>Wireless energy sensor PowerTag up to 630 A</p>	
<p>Compact NSX circuit breaker with embedded metering (with Enerlin'X IFE gateway)</p> 	<p>3P / 4P</p>	<p>Modbus TCP</p>	<p>For 3P, If you want to have power per phase with NSX 3- poles, you must add external neutral voltage tap</p>
<p>Masterpact MTZ circuit breaker with embedded metering (with embedded Enerlin'X EIFE module)</p> 	<p>3P / 4P</p>	<p>Modbus TCP</p>	<p>For 3P, If you want to have power per phase with MTZ 3- poles, you must add external neutral voltage tap</p>

1.2.1.8.1 Modbus registers tables

The following tables show the ModBus registers per type of power meter.

Power meter model	"PM5320, IEM3x5x, Power tag A"
Register @	Description
3000	Current Ph1
3002	Current Ph2
3004	Current Ph3
3054	Power Ph1
3056	Power Ph2
3058	Power Ph3
3060	Total Active Power
3204	Total Active Energy Delivered

Power meter model	"NSX legacy"
Register @	Description
12016	Current Ph1
12017	Current Ph2
12018	Current Ph3
12038	Power Ph1
12039	Power Ph2
12040	Power Ph3
12041	Total Active Power
12050	Total Active Energy Delivered

Power meter model	"NSX"
Register @	Description
32028	Current Ph1
32030	Current Ph2
32032	Current Ph3
32077	Power Ph1
32074	Power Ph2
32076	Power Ph3
32078	Total Active Power
32096	Total Active Energy Delivered

Power meter model	"MTZ"
Register @	Description
32028	Current Ph1
32030	Current Ph2
32032	Current Ph3
32077	Power Ph1
32074	Power Ph2
32076	Power Ph3
32078	Total Active Power
32096	Total Active Energy Delivered

Other power meters that are not part of this selection (refer to [chapter 1.1.1.8](#)) are compatible with EcoStruxure EV Charging Expert as well. When commissioning the power meter, select from the drop-down list on "Model" field the corresponding model of power meter matching the appropriate registers list.

See [chapter 3.6](#) for more information.

1.3 EcoStruxure EV Charging Expert characteristics

1.3.1 General characteristics

Element	Characteristics
Operating System	Linux Yocto
Cooling method	Natural air flow
Weight	1 kg (2.2 lbs)

1.3.1.1 Dimensions

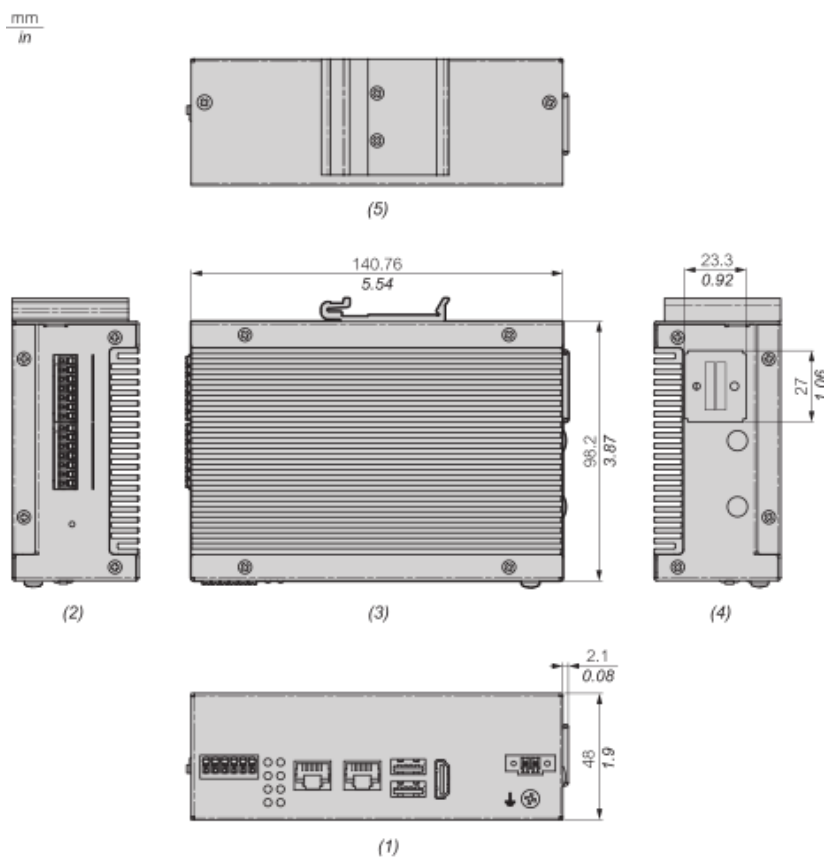

- (1) : Front View
- (2) : Left View
- (3) : Top View
- (4) : Right View
- (5) : Rear View

1.3.2 Environmental characteristics

Characteristics	Value
Degree of protection	IP 20
Operating temperature	-10...55 °C
Operating temperature for horizontal mounting	-10...55 °C
Storage temperature	-40...80 °C
Storage humidity	10...95 % RH at 40 °C (104 °F), no condensation

1.3.3 Power supply characteristics

Element	Characteristics
Rated voltage	24 Vdc
Inrush current	1,5 A
Power consumption	16 W

1.3.4 Communication modules

1.3.4.1 USB interface

Element	Characteristics
Type	USB 2.0
Current load	Maximum 0.5 A
Connection	Type A

1.3.4.2 Ethernet interface

Element	Characteristics
Type	RJ45
Speed	10/100/1000 Mb/s base-T

1.4 Set up of EcoStruxure EV Charging Expert system environment

1.4.1 EcoStruxure EV Charging Expert installation

See EIO0000005096 EcoStruxure EV Charging Expert installation guide” available on the EcoStruxure EV Charging Expert packaging and on se.com/download.

1.4.1.1 Ethernet connection: charging station connection

EcoStruxure EV Charging Expert is connected to the charging station network through ethernet ETH1.

Use an ethernet straight cable between EcoStruxure EV Charging Expert and the charging station Ethernet network.

NOTICE

IMPOSSIBLE TO COMMISSION A CHARGING STATION INTO ECOSTRUXURE EV CHARGING EXPERT

- Connect the charging station network only to ETH 1
- ETH 2 network must be activated through UI (see 3.3 Network Configuration)

Failure to follow this instruction will not enable EcoStruxure EV Charging Expert connectivity and expected functionalities.

1.4.1.2 Power meter connection

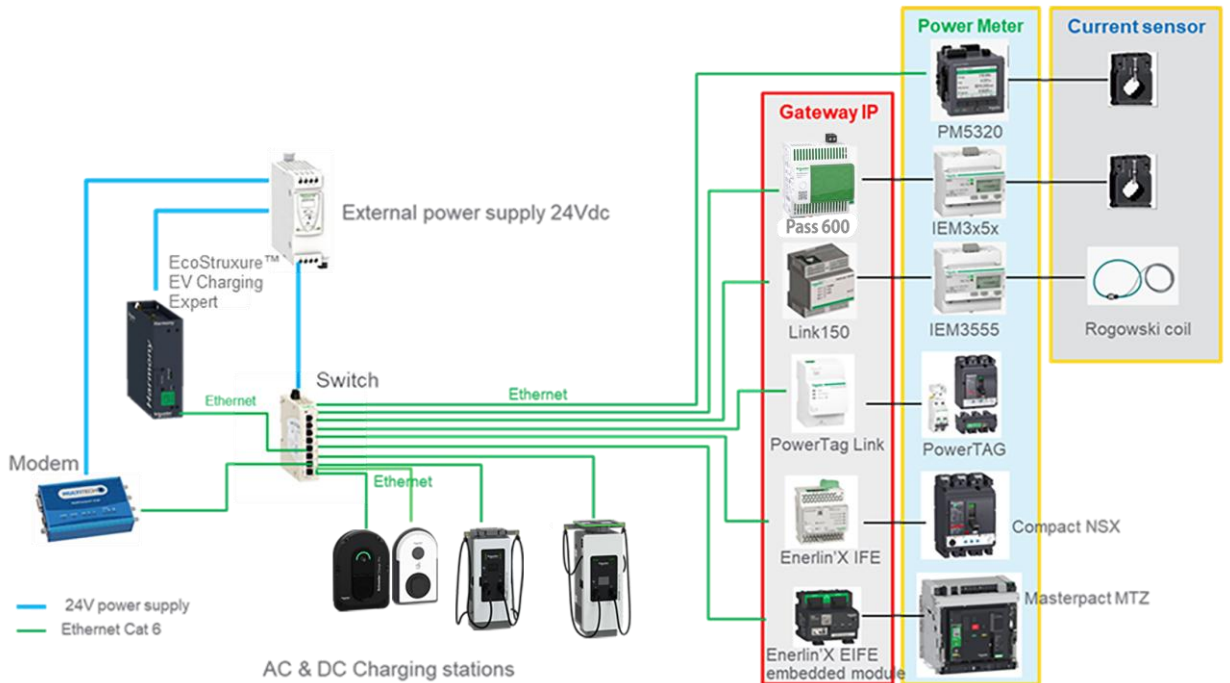

Gateways and power meters must be set correctly before starting the EcoStruxure EV Charging Expert commissioning. Please check the relevant documentation to perform this step.

Note: power metering is only required when the EcoStruxure EV Charging Expert is used in dynamic load management mode.

1.4.1.3 Connection to EMA

EVCE can be connected to EMA using the REST API (see related documents) and the user "EBMS".

 CAUTION
--

It's not possible to be logged in same time by the web interface and by the REST API.
--

1.4.1.4 Connection to EBO (EcoStruxure Building Operation)

EVCE can be connected to EBO with an EBO plugin called "EVCE SmartConnector". Please contact the EBO support for more information.

1.5 Electrical zone definition

An electrical zone is made of one switchboard:

- directly supplying charging stations and possibly other electrical loads,
- or supplying other switchboards of which at least one is supplying charging stations and possibly other electrical loads. This latter forms a sub-zone. The total installed current of all sub-zones must be at least equal to the maximum current that can be delivered by the upper zone switchboard. A maximum of three levels of sub-zones is possible.

For a dynamic zone, a maximum degraded current should be defined in case of power meter disconnection. This maximum degraded current corresponds to the among of available current that is always guaranteed for EV charging.

Example #1: one single zone

In this example, the main switchboard can supply both switchboards at the maximum current. Energy management is required in the zone if the switchboard #1 cannot supply all charging stations and other electrical loads at the same time at the maximum current.

In case of a power meter disconnection, if the maximal building electrical load of the zone is estimated to ~150A, the maximal available current for EV charging in this zone is 100A.

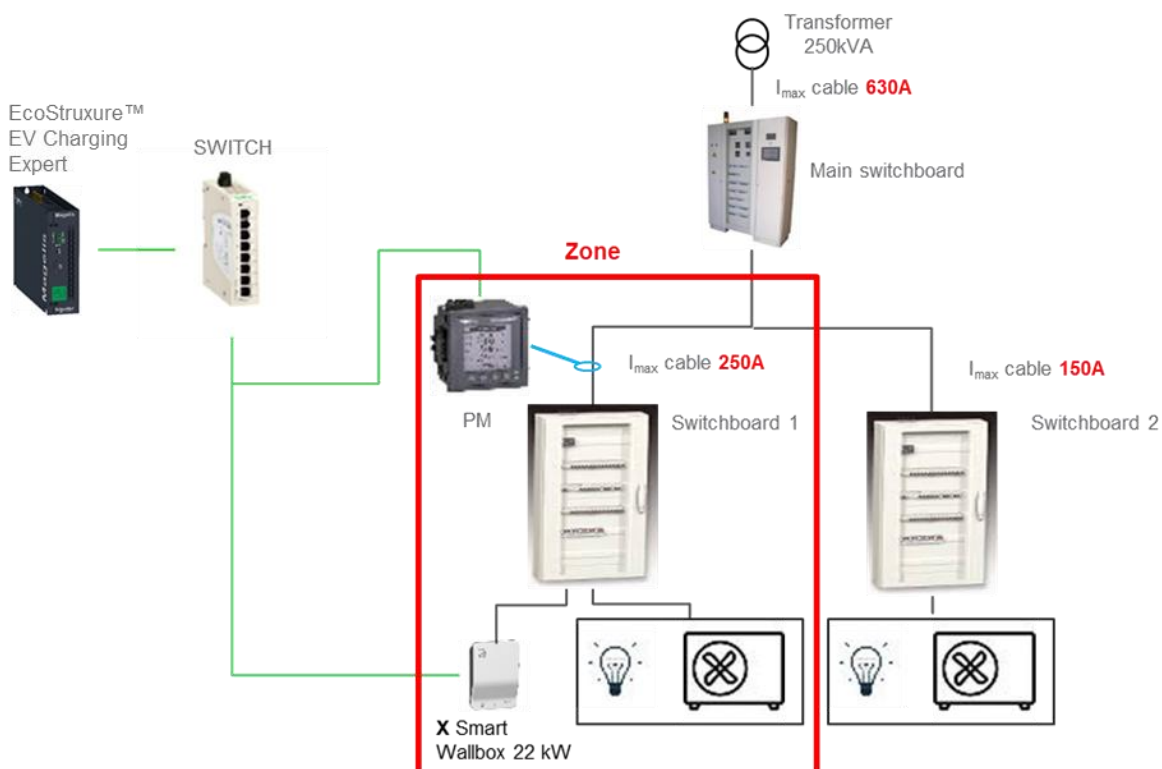

Example #2: one zone with one sub-zone

In this example, the main switchboard cannot supply both switchboards at the maximum current. In the same way, the switchboard #1 cannot supply all charging stations and other electrical loads at the same time at the maximum current.

The current available for EV charging depends on:

- the total consumption of other electrical loads supplied by switchboards #1 and #2 due to the current limitation of the main switchboard (630 A),
- the consumption of other electrical loads supplied by switchboard #1 due to its current limitation (400 A)

In case of power meter disconnection, the maximum degraded current of the top zone should be defined regarding the estimation of the maximum building electrical loads of switchboards #1 and #2.

As a result, it is necessary to define a zone (main switchboard) with a sub-zone (switchboard #1).

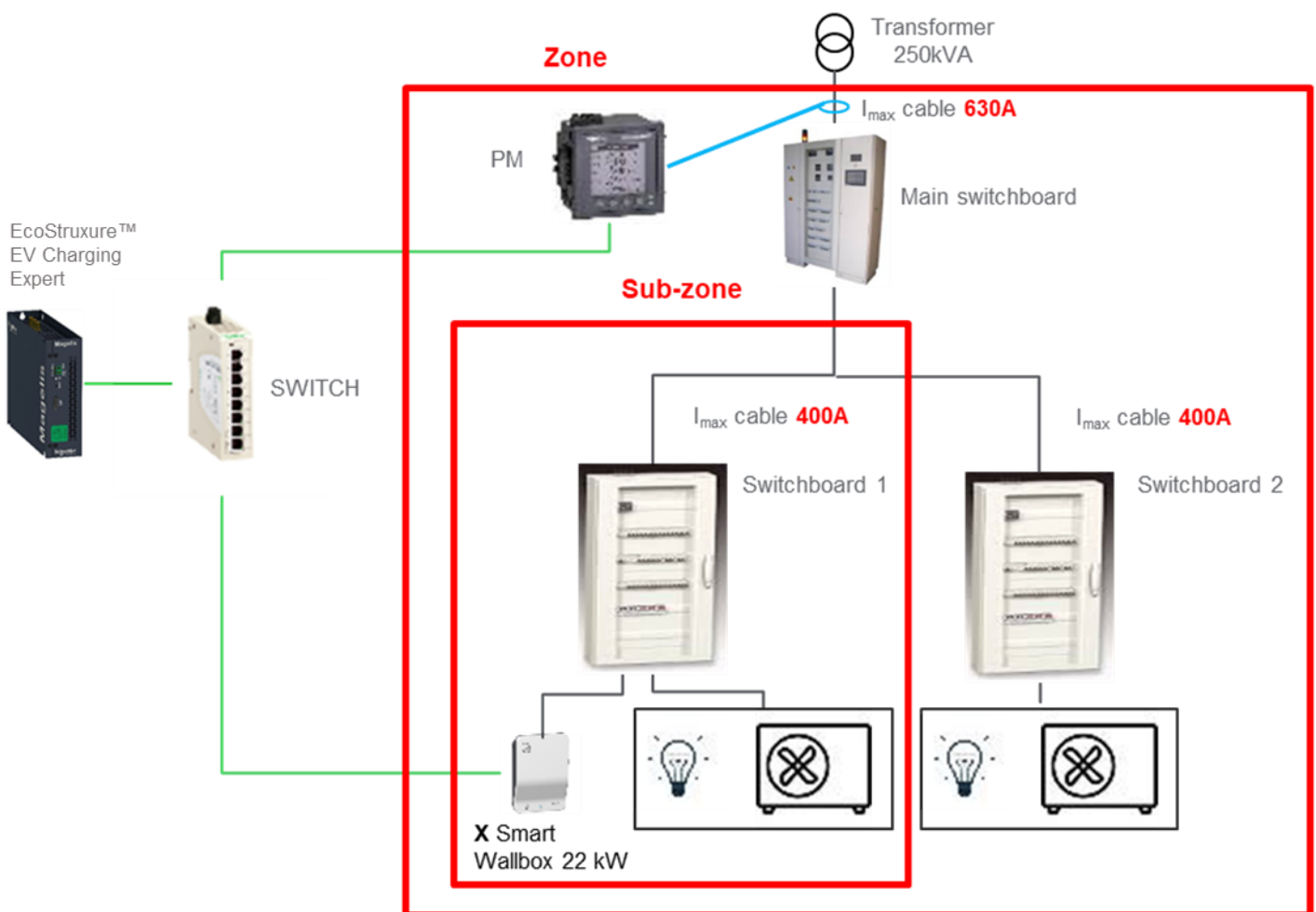

Example #3: two zones at the same level

In this example, the main switchboard can supply switchboards #1 & #2 at the maximum power. Energy management is required in each zone if switchboards #1 and #2 cannot supply all charging stations and other electrical loads at the same time at the maximum power.

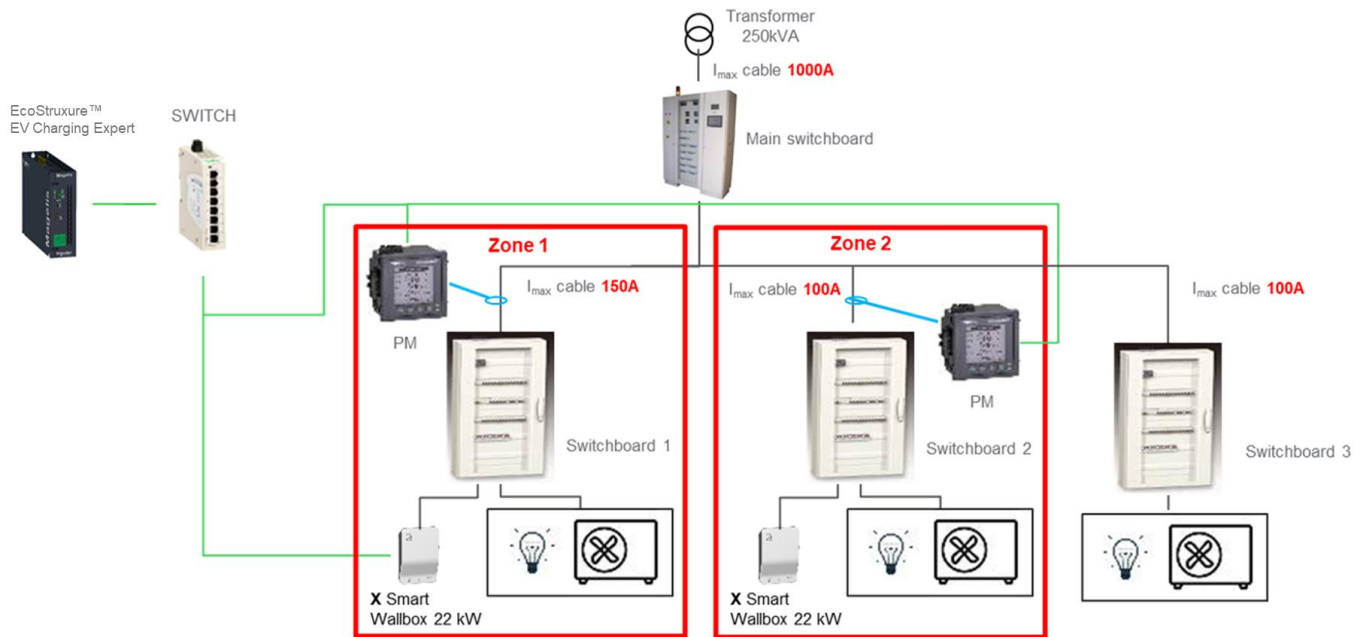

Chapter 2.

EcoStruxure EV Charging Expert

COMMISSIONNING

During the first commissioning, a configuration assistant (**wizard**) will guide the installer to set the EcoStruxure EV Charging Expert. If you have already done the first commissioning, please go to [chapter 3 OPERATION INTERFACE](#).

NOTICE

IMPOSSIBLE TO COMMISSION IN ECOSTRUXURE EV CHARGING EXPERT A CHARGER WITH ONGOING CHARGING SESSION.

- Stop all ongoing charging session
- Unplug all cars connected to the charging station
- Start the EcoStruxure EV Charging Expert commissioning or re-commissioning

Failure to follow these instructions can block the stations pairing with EV Charging Expert.

2.1 Starting with EcoStruxure EV Charging Expert

2.1.1 Computer specification

	Minimum requirements	Recommended requirements
CPU	Intel Core i3 or AMD Ryzen 3	Intel Core i5 or AMD Ryzen 5
RAM	4 Go	8 Go

NOTE: Failure to follow the minimum requirements will have impact on the responsiveness of your internet browser.

2.1.2 Computer configuration

Step	Action
1	Connect your computer to the EcoStruxure EV Charging Expert Ethernet network
2	Open the local network properties menu on your computer
3	Open Internet Protocol TCP/IP v4 properties.
4	Set the static IP address properties as follows: IP address: 192.168.0.x (where x is a number between 50 and 100) Subnet mask: 255.255.255.0 No default gateway No DNS server No proxy

2.1.3 Login to the EcoStruxure EV Charging Expert

Step	Action
1	Open a web browser and type 192.168.0.128 in the URL field

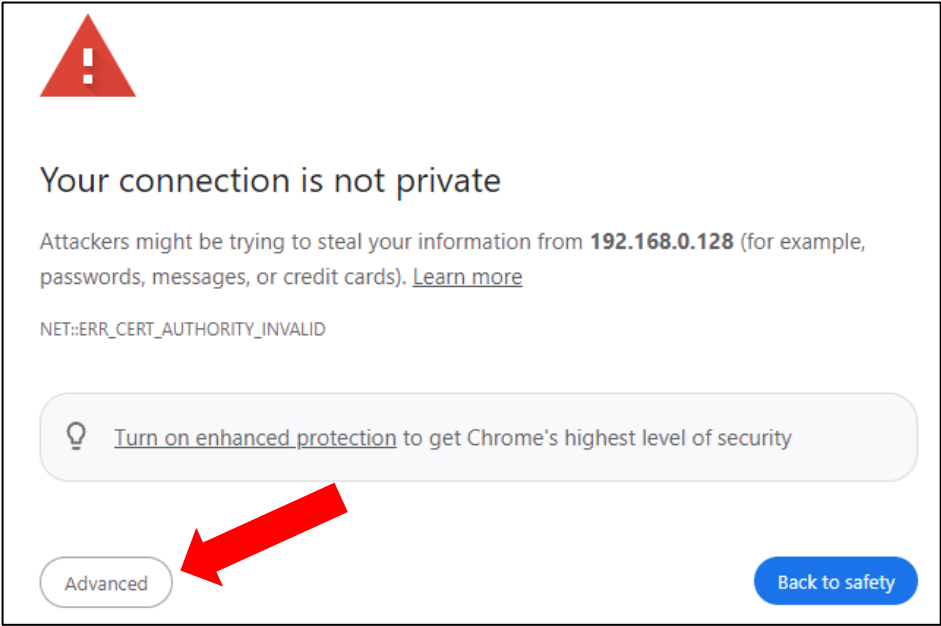
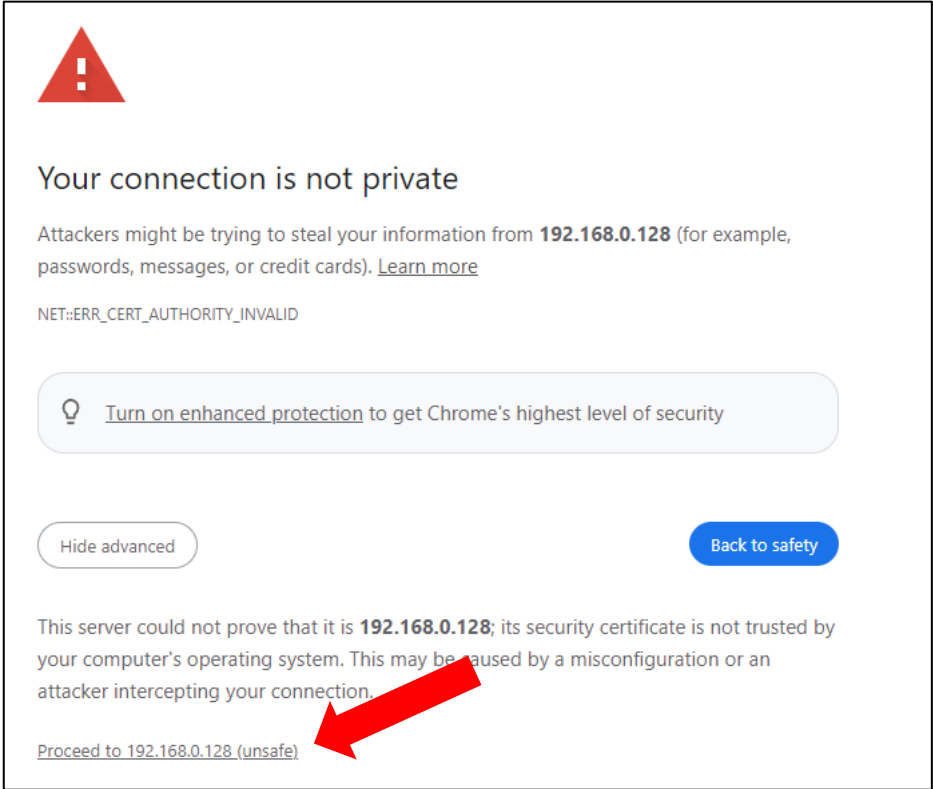
Step	Action
	<p>A security warning may be displayed: click on "Advanced" button if this occurs (see capture below)</p> <div data-bbox="432 264 1377 887"></div> <p>Then click on "Proceed to @ ..."</p> <div data-bbox="440 1014 1377 1800"></div>

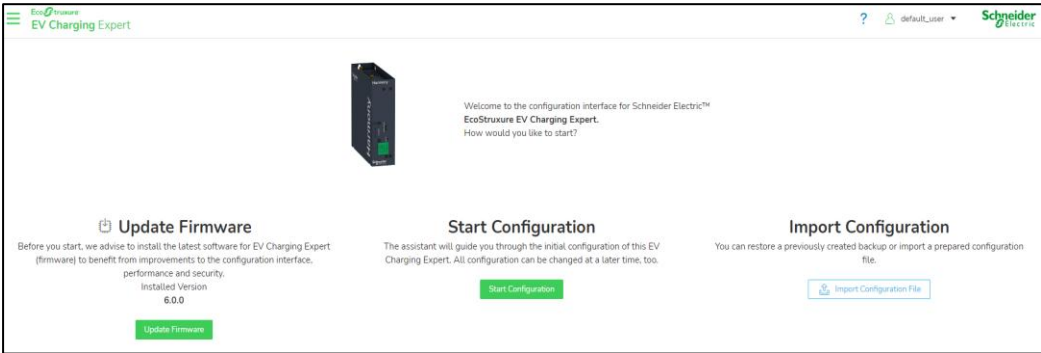
Step	Action
2	<p data-bbox="379 197 1093 226">To start with EcoStruxure EV Charging Expert, there are 3 options:</p> <div data-bbox="379 259 1425 611" style="border: 1px solid black; padding: 10px;">  <p data-bbox="475 472 632 497">Update Firmware</p> <p data-bbox="395 499 711 566">Before you start, we advise to install the latest software for EV Charging Expert (firmware) to benefit from improvements to the configuration interface, performance and security. Installed Version 6.0.0</p> <p data-bbox="517 577 587 595">Update Firmware</p> <p data-bbox="826 472 976 497">Start Configuration</p> <p data-bbox="762 499 1040 526">The assistant will guide you through the initial configuration of this EV Charging Expert. All configuration can be changed at a later time, too.</p> <p data-bbox="863 539 938 557">Start Configuration</p> <p data-bbox="1171 472 1334 497">Import Configuration</p> <p data-bbox="1094 499 1409 526">You can restore a previously created backup or import a prepared configuration file.</p> <p data-bbox="1193 539 1310 557">Import Configuration File</p> </div> <ul data-bbox="427 667 1436 851" style="list-style-type: none"> • Update the firmware: It is recommended to update the product with the latest version of firmware that has been issued. The file needs to be available locally, hence the installer needs to download it previously from se.com. • Start new configuration : chapter 2.3 • Import EcoStruxure EV Charging Expert: chapter 3.20.2

2.2 Credentials configuration

In EcoStruxure EV Charging Expert there are two different user profiles:

- **Administrator:** Access to all configuration parameters and features, dashboard operation and RFID card management.
- **Operator:** Dashboard operation and RFID card management.

The screenshot shows the 'Set Login Credentials' page in the EcoStruxure EV Charging Expert interface. The page is divided into two main sections: 'Administrator' and 'First User'. The 'Administrator' section includes a warning about unauthorized access, a title 'Administrator', and instructions that the administrator has access to all configuration. It contains three input fields: 'Username', 'Password', and 'Repeat Password'. The 'Password' field has a note: 'You should not use Root, Admin or Administrator, as they are easy to guess'. The 'Repeat Password' field has a note: 'Your password must satisfy the following conditions at least 12 characters long lowercase characters uppercase characters numbers special characters (@!%?&)' and a checkbox for 'I securely stored these credentials. A factory reset is the only option if they get lost'. The 'First User' section includes a title 'First User' and instructions: 'After initial configuration, users can monitor the installation's status, and manage badges. Please create one first user here, you can add more users later.' The page has a 'Previous' button on the left and a 'Save and Next' button on the right.

At the credentials step, the installer is asked to create an administrator profile and a user profile.

The passwords must satisfy the following conditions:

- at least 12 characters long lowercase
- characters uppercase
- characters numbers
- special characters (@!%?&).

The login cannot be “Root”, “Admin” or “Administrator”.

2.3 Wizard steps

The wizard allows to configure EcoStruxure EV Charging Expert with only 10 steps.

2.3.1 Network

See [chapter 3.3](#)

2.3.2 Remote supervision

See [chapter 3.4](#)

2.3.3 Date & Time

2.3.4 Energy management

See [chapter 3.5](#)

2.3.5 Stations configuration

See [chapter 3.6](#)

2.3.6 Power meter configuration

See [chapter 3.7](#)

2.3.7 Zones configuration

See [chapter 3.8](#)

2.3.8 Station assignment

See [chapter 3.8.5](#)

2.3.9 Authentication group

See [chapter 3.11.1](#)

2.3.10 RFID Cards

See [chapter 3.11.2](#)

Chapter 3.

OPERATION INTERFACE

3.1 Menu and status bar

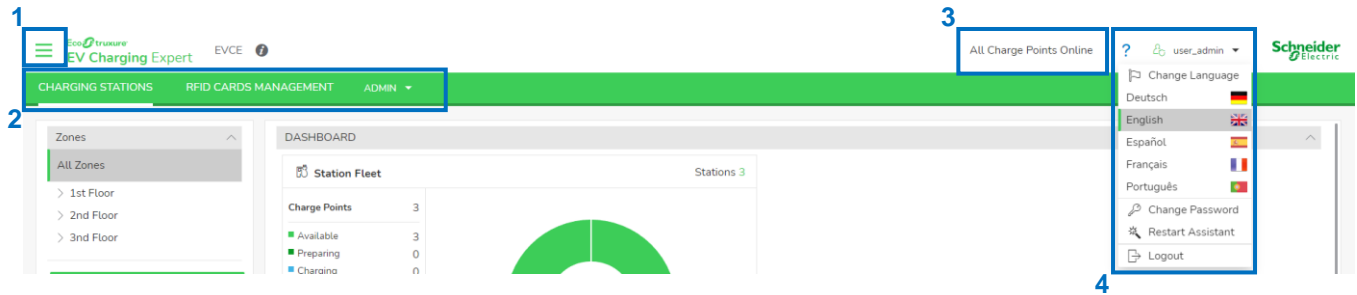

Mark	Description
1	Menu to update EcoStruxure EV Charging Expert and upgrade licence
2	Administrator menu to manage configurations
3	Charging station status (Online/Offline/Faulted state)
4	User management: <ul style="list-style-type: none"> • Change language • Update password • Restart assistant: restart wizard menu • Logout

3.2 Dashboard

3.2.1 Global view

This page displays the ongoing status of the charging stations, load transaction information and zone configuration. Furthermore, it's possible to manage charging stations (reboot/remote start & stop/diagnostic report).

The screenshot displays the 'EV Charging Expert' dashboard with the following components:

- Zones (1):** A sidebar menu showing a hierarchical view of zones: All Zones, 1st Floor (1st Floor - South, 1st Floor - North), 2nd Floor, and 3rd Floor. An 'Export Transactions' button is visible at the bottom.
- DASHBOARD (2):** A 'Station Fleet' overview showing 3 stations. A donut chart displays the status distribution: Available (2), Preparing (0), Charging (1), Suspended by Vehicle (0), Suspended by System (0), Finishing (0), Faulted (0), Unavailable (0), and Unknown (0).
- TRANSACTION (3):** A table showing a single transaction with the following details:

ID	Station	RFID Card	Status	Phase	Date/Duration	Energy	Setpoint	Consumption
1	A11223344001	SIMTAG	Charging	1 2 3	15/07/2024, 09:34:57 1 minute	0.33 kWh	32 A	31.93 A
- STATIONS (4):** A table showing station assignment and management:

Name	Zone	Connector	Status	Phase
A11223344001	1st Floor - South	1	Charging	TRI123

The global view is made of four parts:

1. Electrical zone topology and transactions exports information.
2. Dashboard with zones and charging stations information.
3. Transaction information and management.
4. Stations assignment and management.

3.2.2 Zone view

The screenshot displays the 'Zone view' dashboard in the EcoStuxure EV Charging Expert interface. On the left, a sidebar shows 'Zones' with a tree view including 'All Zones', 'Site', 'Parking', 'Employee Parking', and 'Visitor Parking'. The main dashboard area is titled 'DASHBOARD' and contains three primary visualizations:

- Station Fleet:** A donut chart showing the status of 12 charging points. The legend indicates: Available (10), Preparing (0), Charging (0), Suspended by V... (2), Suspended by S... (0), Finishing (0), Faulted (0), Unavailable (0), and Unknown (0).
- Current Repartition:** A horizontal bar chart showing current and available current for three levels (L1, L2, L3) across two phases (0A and 720A). The legend for 'Used Current' includes Allocated and Reserved. The legend for 'Available Current' includes Grid and Local.
- Zone Consumption:** A horizontal bar chart showing energy and power consumption for three levels (L1, L2, L3) across two phases (0A and 720A). Total energy consumption is 1643423 kWh and power is 157 kW.

 Below these charts is an 'INFORMATION' section with settings: Dynamic Mode (ON), Setpoint (720 A), Degraded Mode (200 A), and Type of local production (Grid only). At the bottom, a 'TRANSACTION' table lists two transactions:

ID	Station	RFID Card	Status	Phase	Date/Duration	Energy	Setpoint	Consumption
216	Borne_1 1	26117D01	Suspended by Vehicle		09/01/2025, 06:55:56 2 hours, 42 minutes	12.42 kWh	32 A	0 A
217	Borne_3 1	26197826	Suspended by Vehicle		09/01/2025, 08:36:01 1 hour	11.28 kWh	32 A	0 A

Zone view is available when a zone is selected in the zone topology panel. The zone view provides below data:

- **Station Fleet:** Status of charging stations assigned to the zone.
- **Current Repartition:** Charging setpoint available according to the active zone maximum current, zone consumption and transactions information.
 - **Allocated:** Allocated current to charging stations during transaction
 - **Reserved:** Reserved current for building consumptions and disconnected stations (degraded setpoint apply to charging station).
 - **Grid:** Available current from grid (with reduction)
 - **Local:** Available current from local production
- **Zone Consumption** (only for dynamic zone): Consumption of the zone reported by assigned power meter.

Name	Zone	Connector	Status	Phase
A11223344001	1st Floor - South	1	Charging	TR1123

Zone view is enabling charging stations management:

- **Remote start** ▶: Start a charging session (deactivated when supervision is configured).
- **Diagnostic** ↓: Generate a manual charging station report of the charging station (see [chapter 3.16.3](#) for download page).
- **Configuration** ✎: Update charging station configuration (see [chapter 3.2.4](#)).
- **Webserver** 🌐: Webserver of the charging station (option available only for charging station supporting web pages interface).
- **Reboot** 🔄
- **Delete** 🗑️: Delete charging station configuration into EcoStuxure EV Charging Expert (impossible to delete a charging station with an ongoing transaction).

3.2.3 Transaction view

Transaction view provides all information for an active transaction:

- **ID:** Unique identifier of the transaction
- **Station:** Station name and connector used for the charging session
- **RFID Card:** Card which launch the transaction.
- **Status:** Status of the transaction according to OCPP standard (Charging / SuspendedEV / SuspendedEVSE / Finishing)
- **Phase:** Selected phases by EV (mono-phase or tri-phased)
- **Date/Duration:** Transaction start date and effective charging duration (time passed in charging state)
- **Energy:** Energy consumed by the ongoing transaction
- **Setpoint:** Current setpoint (intensity or power allocated to the charging station).
- **Consumption:** Consumption of the charging station.

At the left of ongoing charging session, it's possible to remotely stop the charging sessions with the button , a **Force Remote Stop** option is available to stop a charging session if there are some troubles with this charging session.

Transaction logs are available for download by using **Export Transactions** button. Select a start and end date to make a partial transaction export.

3.2.4 Station view

To access the station details, select the charging station in zones hierarchy. Below information is accessible:

- **Name:** Name of the charging station into EcoStruxure EV Charging Expert.
- **Charge Box Identity:** Name of the charging station for the remote supervision.
- **VIP:** Select this option to activate VIP for the charging station.
- **Phase configuration:** Electrical configuration of charging station (see [chapter 3.5.4](#))
- **Vendor:** Vendor of the charging station.
- **Firmware:** Firmware version and management (see [chapter 3.13](#)).
- **Degraded Mode:** Current allocated to the charging station in degraded mode (see [chapter 3.7.4](#)).

The screenshot displays the EcoStruxure EV Charging Expert interface. On the left, a 'Zones' sidebar shows a hierarchy: 'All Zones' > '1st Floor' > 'A11223344001' (selected). Below the sidebar is an 'Export Transactions' button. The main content area features a confirmation dialog: 'Do you want to stop the transaction?' with a 'Force Remote Stop' checkbox and 'Confirm'/'Cancel' buttons. Below the dialog is a 'LOGS' section with a search filter for device 'A11223344001' and buttons for 'Download Logs' and 'Refresh'. The log table contains the following data:

Date	Device	Type	Sub Type	Message
15/07/2024, 16:41:52	A11223344001	OCCP	StatusNotification	Connector = 1 - Status = Charging - Error = NoError
15/07/2024, 16:41:51	A11223344001	OCCP	StatusNotification	Connector = 1 - Status = SuspendedEVSE - Error = NoError
15/07/2024, 16:41:33	A11223344001	OCCP	StatusNotification	Connector = 1 - Status = Charging - Error = NoError
15/07/2024, 16:41:31	A11223344001	OCCP	StatusNotification	Connector = 1 - Status = SuspendedEVSE - Error = NoError
15/07/2024, 16:41:13	A11223344001	OCCP	StatusNotification	Connector = 1 - Status = Charging - Error = NoError
15/07/2024, 16:41:11	A11223344001	OCCP	StatusNotification	Connector = 1 - Status = SuspendedEVSE - Error = NoError
15/07/2024, 16:40:53	A11223344001	OCCP	StatusNotification	Connector = 1 - Status = Charging - Error = NoError
15/07/2024, 16:40:51	A11223344001	OCCP	StatusNotification	Connector = 1 - Status = SuspendedEVSE - Error = NoError

In station view, a log section displays all OCCP commands received by EcoStruxure EV Charging Expert from the selected charging station.

3.3 Network configuration

Access by the Admin tab → Configuration → Network

The screenshot shows the 'Network' configuration page. At the top, the 'Device Name' is 'EVCE'. Below it, 'Proxy Configuration' is set to 'OFF'. The 'EV Network' section has 'Activate DHCP client' set to 'OFF', IP Address '192.168.0.150', Subnet Mask '255.255.254.0', and Default Gateway '192.168.0.1'. The 'DNS Server' section has Preferred DNS Server '8.8.8.8' and Alternate DNS Server blank. 'DHCP Server Configuration' is 'OFF'. The 'Secondary Network' section has 'Activate DHCP client' set to 'ON', IP Address '192.168.1.128', Subnet Mask '255.255.255.0', and Default Gateway blank.

3.3.1 EcoStruxure EV Charging Expert name

It is mandatory to define a name to EcoStruxure EV Charging Expert.

3.3.2 Network configuration

This block compares the configuration for the 'EV Network' and the 'Secondary Network'. For the EV Network, 'Activate DHCP client' is OFF, IP is 192.168.0.151, mask is 255.255.255.0, and gateway is blank. For the Secondary Network, 'Activate DHCP client' is ON, IP is 192.168.1.128, mask is 255.255.255.0, and gateway is blank.

Fields	Factory setting	Description
EV network		
Activate DHCP client	Activated	Activate or not the DHCP client. The device IP address will change based on the DHCP if you activate this.
IP address	192.168.0.128	EcoStruxure EV Charging Expert IP address
Network mask	255.255.255.0	EcoStruxure EV Charging Expert sub-network mask
Default gateway (1)	192.168.0.254	Gateway IP address. Mandatory to connect two networks so that devices on one network can communicate with the devices of another network.
Preferred DNS server (2)	8.8.8.8	Preferred DNS server IP address (2)
Alternative DNS server	-	Other DNS server IP address (2)
Secondary Network		
	Deactivated	Activate another subnetwork on the second ethernet port to access the web pages

- (1) Address of the modem used for the connection to the supervision, if any. All charging stations on the same sub-network than EVCE must be configured with the same gateway IP address.
- (2) DNS Server is used to convert URL to IP address. May be provided by the remote supervision (through a dedicated SIM card for example). Google DNS server by default.

NOTICE**PRESENCE OF CHARGING STATIONS IN A DIFFERENT SUBNETWORK OF ECOSTRUXURE EV CHARGING EXPERT**

Configure for each charging station gateway and DNS information

Failure to follow these instructions can result in a network issue for all connected devices.

3.3.3 Proxy configuration

Proxy URL: Proxy URL when proxy is used as an intermediary between a user's device and the internet, enhancing security by masking the user's IP address, allowing organizations to control and monitor internet usage, and enabling access to geo-blocked or restricted content.

3.3.4 DHCP server configuration

DHCP: Dynamic Host Configuration Protocol is a protocol used to provide quick, automatic, and central management for the distribution of IP addresses within a network.

EcoStruxure EV Charging Expert can be configured to act as a DHCP server to assign IP addresses to charging stations in the defined range.

by-default sub-network (192.168.0.0-255) is being used. The use of 192.168.0.0, 192.168.0.254 and 192.168.0.255 are to avoid.

NOTICE**PRESENCE OF A DHCP SERVER ON THE NETWORK WHICH CONFLICTS WITH ECOSTRUXURE EV CHARGING EXPERT DHCP SERVER.**

Deactivate EcoStruxure EV Charging Expert DHCP server

Failure to follow these instructions can result in a network issue for all connected devices.

3.4 Remote supervision configuration

Access by the Admin tab → configuration → remote supervision

3.4.1 Supervision selection

The screenshot shows the 'Remote Supervision Configuration' page. Under the 'Supervision mode' section, the 'Local' option is selected with a radio button. The 'Unique' and 'Multiple' options are unselected. There are help icons next to each option. A green 'Save' button is located at the bottom left of the configuration area.

There are 3 types of EcoStruxure EV Charging Expert supervision:

- **Local:** EcoStruxure EV Charging Expert is managing authentication rules and badges. See [chapter 3.11](#)
- **Unique:** One supervision is managing authentication rules and badges of the complete installation
- **Multiple:** Charging stations are divided in groups managed by a specific supervision or by EcoStruxure EV Charging Expert

3.4.2 Unique supervision

The screenshot shows the 'Remote Supervision Configuration' page with 'Unique' selected as the supervision mode. In the 'Advanced Configuration' section, the 'Remote Supervision URL Address' is set to 'ws://test.com', 'Websocket Ping Interval' is 10, and 'Message timeout' is 10. The 'Forward security event to CPO' and 'Basic Authentication' options are both turned ON. There are 'Save' and 'Test Connection' buttons at the bottom left.

3.4.2.1 Prerequisites

Remote supervision must be enabled to allow its configuration. Enter the URL to be used by the charging stations to establish communication with the remote supervision. The communication protocol **must be OCPP 1.6 Json**.

3.4.2.2 Supervision configuration

- **URL Address:** Enter WebSocket (ws) or WebSocket Secure (wss) URL. It is recommended to use a WebSocket secure as a good practice of cybersecurity. In this case, it is necessary to add a certificate after commissioning steps, see [chapter 3.12](#).
- **Websocket Ping Interval:** Positive values are interpreted as number of seconds between pings. Value must be between 1 and 60s
- **Message timeout:** Interval between request and response OCPP message before considering the connection lost. Value must be between 1 and 60s
- **Forward security event to CPO:** Authorize to forward security event to supervision

3.4.2.3 Basic authentication

Add a Basic Authentication password for all charging stations to secure communication between EcoStruxure EV Charging Expert and supervision. There are 2 options:

- **One password by station:** One unique password for each station. To add or change basic authentication password, it's necessary to select charging station into installation page and click on **Change password**.

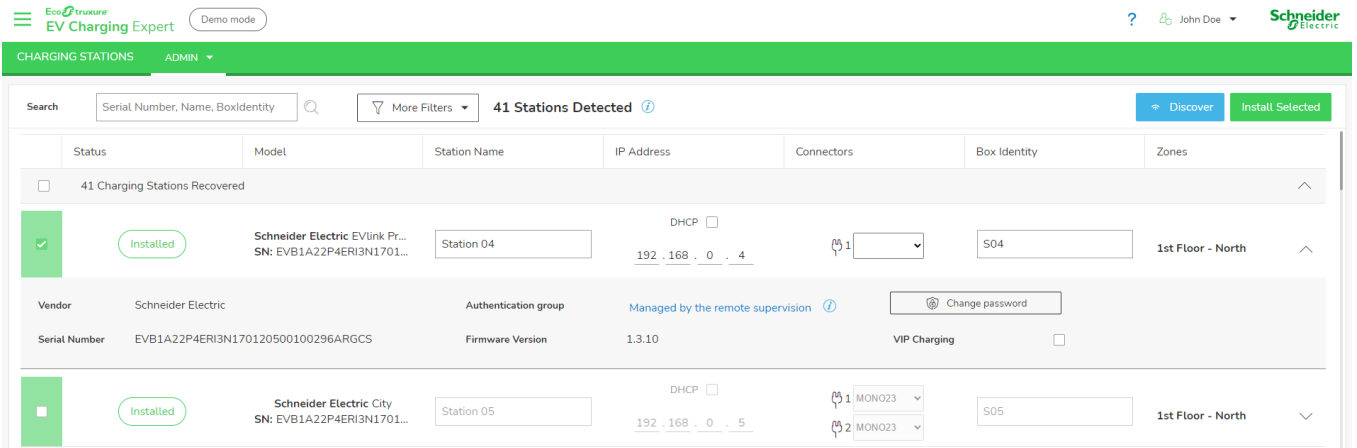

- **Same password for all charging stations:** Once the option is selected, a popup will appear offering the possibility to add basic authentication key according to 2 formats (ASCII or HEXA format). Password is used for all stations and can be changed later by supervision through OCPP commands.

3.4.2.4 Restrictions

If remote supervision option is activated, it is the responsibility of the remote supervision system to handle EV driver authentication and to consider charging station specific keys for authentication management.

When the remote supervision is activated, the date and time are provided by the remote supervision even if time zone still has to be configured in the next panel (Date & Time).

3.4.3 Multiple supervision

3.4.3.1 Supervision configuration

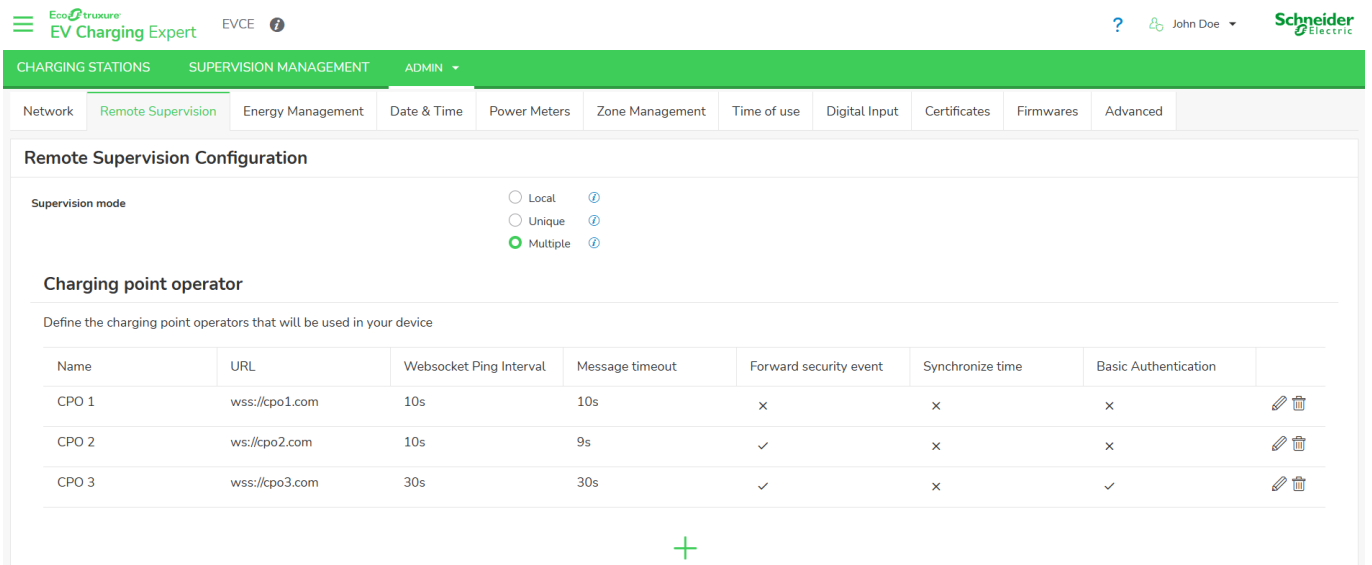

To manage supervisions, it is necessary to click on + and refer to [chapter 3.4.2](#) to configure a supervision.

3.4.3.2 Supervision management

The screenshot displays the 'EV Charging Expert' interface. At the top, there are navigation tabs: 'CHARGING STATIONS', 'SUPERVISION MANAGEMENT', and 'ADMIN'. Below these, there are sub-tabs for 'Authentication groups' and 'RFID cards list'. The main content area is titled 'Authentication groups' and includes a 'Sort A-Z' dropdown and a 'Select All Groups' button. On the left, there is a list of 'Unassigned' stations from Station 03 to Station 11. The main area shows two configuration cards for 'CPO One' and 'Free parking'. The 'CPO One' card has a 'Charging point operator' dropdown menu open, showing options: 'CPO 1', 'Local', 'CPO 2', 'CPO 3', and '+ Create'. The 'Free parking' card also has a 'Charging point operator' dropdown set to 'Local'. Both cards show a 'Chargers' table with columns for 'Device name', 'Box ID', and 'IP Address'. The 'CPO One' card shows Station 06 with IP 192.168.0.6. The 'Free parking' card shows Station 02 with IP 192.168.0.2. There are also 'Authentication mode' and 'Offline strategy' settings for each card, both set to 'Authorize all RFID Cards'.

Multiple supervisions option offers the possibility to manage authentication strategy according to supervision or local strategy. To manage the installation, it is necessary to create authentication groups and assigned charging stations to a group. An authentication group is a selection of charging stations associated with to a charging point operator. There are 2 charging point operator options:

- Select a **supervision as charge point operator**: select in the list the supervision already configures.
- Select **local as charge point operator**: please see chapter [3.11.1.2](#) and to manage RFID card, please see chapter [3.11.2](#).

3.5 Energy management configuration

Access by the Admin tab → configuration → energy management

The screenshot displays the 'Energy Management' configuration page in the Schneider Electric EV Charging Expert interface. The page is organized into several sections:

- Charging Stations Default Configuration:**
 - Minimum current setpoint for an electrical vehicle to charge: Radio buttons for IEC 61851 (6A Single- and Three-phase) and EV/ZE Ready (8A Single-phase/14A Three-phase). The EV/ZE Ready option is selected.
 - Load Shedding Priority: A dropdown menu set to 'Energy'.
- Consumption Optimisation Configuration:**
 - Activation: A toggle switch set to 'ON'.
 - Setpoint reduction trigger value: Input field with '10'.
 - Reduction efficiency value: Input field with '10'.
 - Minimal gap with EV consumption: Input field with '10'.
 - Optimization delay (s): Input field with '30'.
- Suspended by System Strategy:**
 - Strategy: Radio buttons for 'Allow', 'Disabled', and 'Reused setpoint'. 'Allow' is selected.
- Electrical grid:**
 - Type of electrical network: Radio buttons for '3 x 400V with neutral' (selected) and '3 x 230V no neutral'.
- Local production management:**
 - Type of local production: Radio buttons for 'Grid only', 'Local production + Grid' (selected), and 'Local production only'.

A 'Save' button is located at the bottom left of the configuration area.

3.5.1 Load shedding configuration

Load shedding mechanism is activated once there is not enough available current in a zone to provide floor value to all charges simultaneously. When such a situation happens, chose between energy or duration priority: to favor the newest transactions or the transactions that delivered the lowest amount energy:

- **Energy:** Proportional to the energy consumed (kWh). Favour transaction which has delivered the lowest amount energy. This option is set by default.
- **Duration:** Proportional to the charging time. Favour transaction which has the lowest charging time

The charging station floor value is defined by IEC 61851 and EV/ZE standard for AC installation:

- IEC 61851 (6A in both single and 3-phases connection)
- EV/ZE ready (8A in single-phase, 14A in 3-phase connection)

3.5.2 Consumption optimization configuration

Consumption optimization mechanism is activated to manage energy management with different parameters:

- **Setpoint reduction trigger value:** Difference between decreasing EV consumption and setpoint before triggering the optimization.
- **Reduction efficiency value:** Gap between the consumption and the new setpoint calculated by the optimization.
- **Minimal gap with EV consumption:** Gap between the increasing EV consumption and the setpoint triggering more power allocation to the charging station.

3.5.3 Allow Suspended by System

If a transaction stop consuming energy (current lower than 1A), EcoStruxure EV Charging Expert can pause the transaction (Suspended by System) and restart transaction after a wake-up interval defined in second.

3.5.4 Local production management

3.5.4.1 Prerequisites

To manage local production there are 3 options:

- **Grid only** (selected by default): Power coming only from grid
- **Local production + grid**: Local solar production is added to power coming from utility for higher consumption capacity.
- **Local production only**: Enable green charging by considering solar energy only as available power for your EV charging installation

3.5.4.2 Local production

If 2nd or 3rd option are chosen, then it is necessary to add power meter dedicated to solar production. Please see [chapter 3.7.2](#) to add a power meter and [chapter 3.8.3](#) to associate the local production to an electrical zone.

For reduction, when it is applied with EBMS, time of use or DI it concerned only the maximum current of the zone, additional current provides by local production are not consider.

For example, a zone with 100A a reduction to 70% with a solar production of 20A. After energy management computation there is 90A available for the charging stations.

Note: The power meter wiring must include a neutral and be wired in the correct direction. Failure to follow these instructions can result in an installation trip.

3.5.4.3 Example

For example, there is a dynamic electrical zone on 70A with solar production and 3 charging stations associated to the electrical zone.

The schematic of the installation:

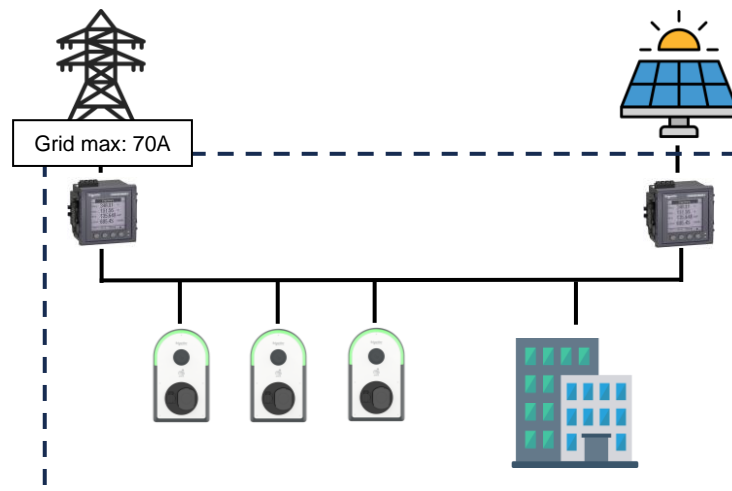

Zone configuration: Main zone has 70A maximum current and MainPowerMeter is the power meter associate to the electrical zone to compute consumption of charging stations and building. SolarPowerMeter is the power meter associated to the local production into the electrical zone.

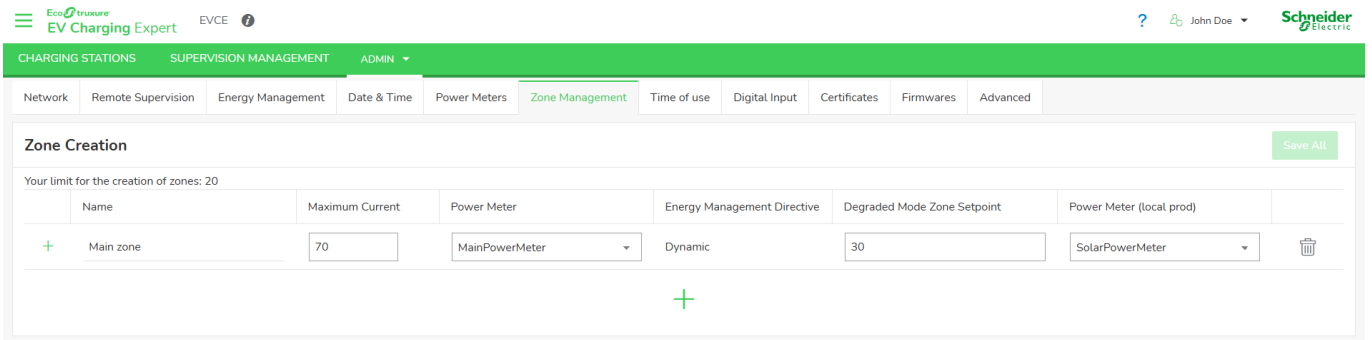

Dashboard:

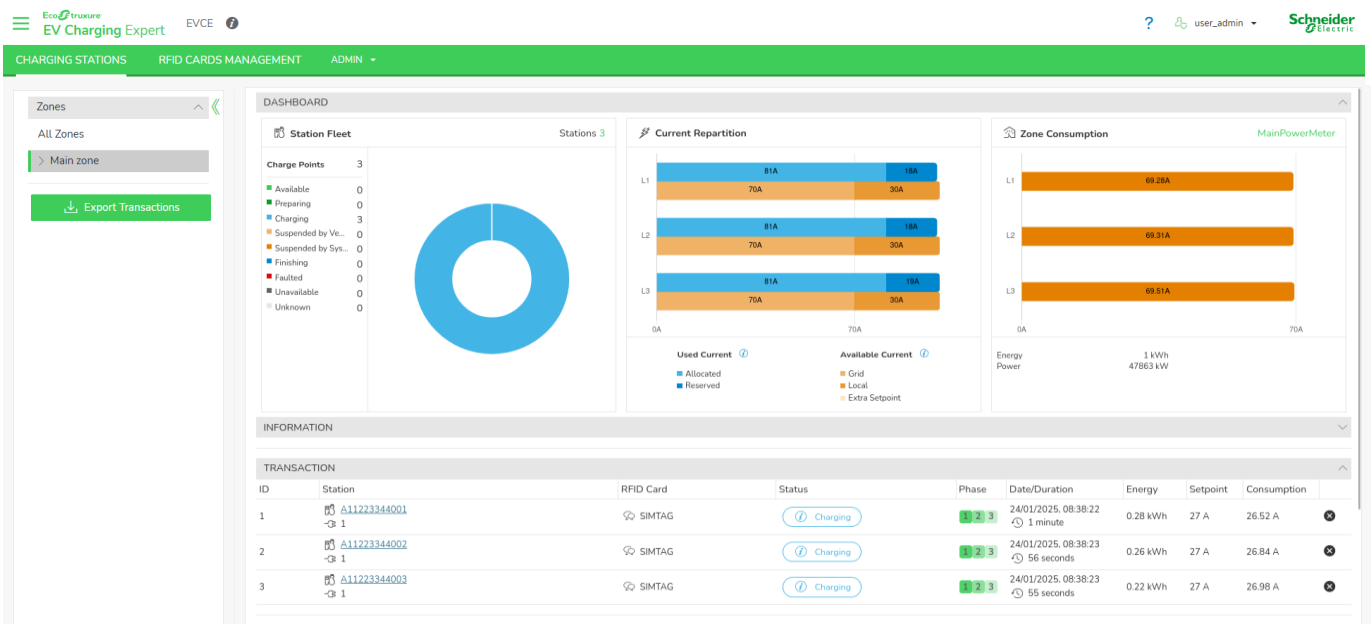

On the dashboard there is 3 transactions in progress, maximum current of the zone is 70A but it is increase to 100A with 30A of local production. And the building consumes 19A. So the energy management computation gives 27A for each transaction:

$$\frac{(Max\ current+Local\ production)-Building\ consumption}{Number\ of\ transaction} = \frac{(70A+30A)-19A}{3} = 27A$$

3.6 Charging stations commissioning

Access by Admin tab → configuration → Installation

3.6.1 Prerequisites

Charging stations must be powered on and connected to the network before the EcoStruxure EV Charging Expert commissioning. Charging stations must have a compatible firmware version, see [chapter 1.1.2.1 EVlink charging stations](#)

NOTICE

IMPOSSIBLE TO INSTALL CHARGING STATION WITH WEBSERVER OPENED.

Close charging station webserver

Failure to follow these instructions can result in an impossibility of installing a charging station.

NOTICE

RESTRICTIONS ON CHARGING STATIONS IP ADDRESSES AND BOX IDENTITIES

- Avoid the use of sub-network addresses +0, +MAX, +MAX-1. If the by-default sub-network (192.168.0.0-255) is being used, avoid the use of 192.168.0.0, 192.168.0.254 and 192.168.0.255.
- Charging stations box identities must contain only a-z, A-Z, 0-9, '*', '-', '_', '=', '+', '|', '@', '!'.
- Charging stations box identities should not contain any space
- Charging stations box identities must not exceed 30 characters
- Charging stations box identities must be unique by station.

Failure to follow these instructions can result in an impossibility of installing a charging station.

3.6.2 Charging station installation page

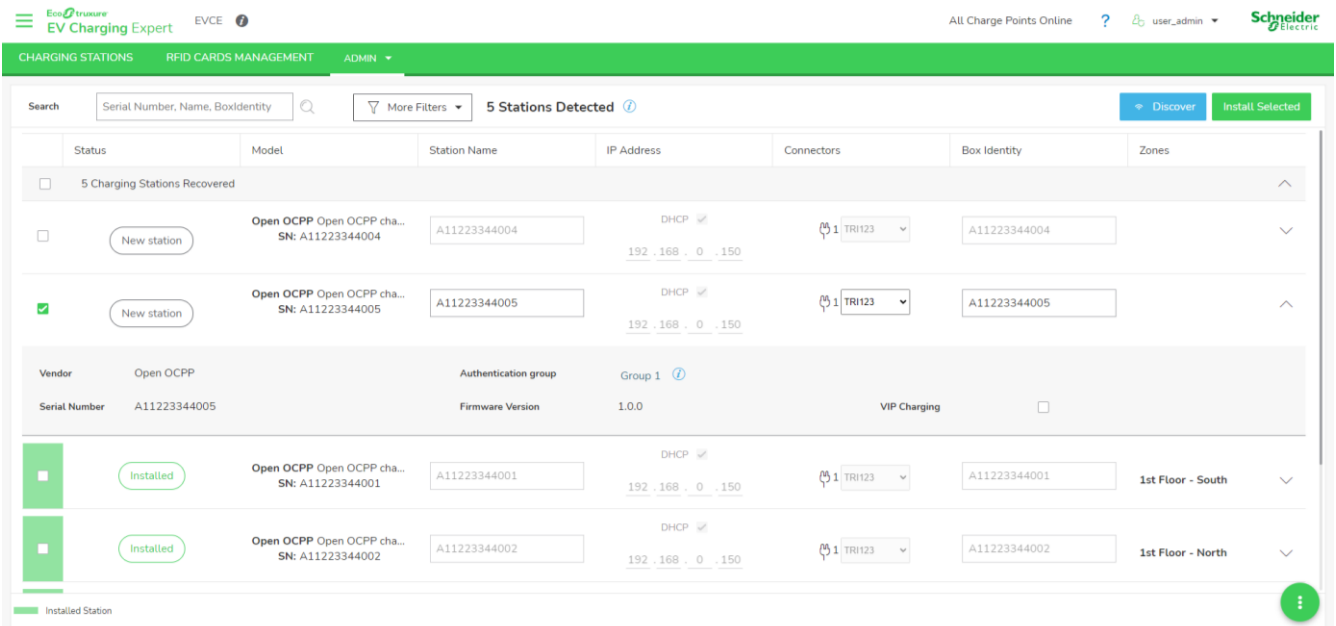

All charging stations already installed are present into the installation page before to launch a network discovering. To detect all new charging stations and proceed to installations, first click on **Discover** button to launch a network scan of all stations.

3.6.3 Charging station status

In charging station installation page after a discovery, some stations may not be installed. Below are the possible reasons:

- Current charging station version is not supported by EcoStruxure EV Charging Expert (see [chapter 1.1.2.1](#)). In this case the station must be upgraded to a compatible version first.

Warning	Schneider Electric EVLink Pr... SN: A21301010232	192.168.0.223	Information Unable to install this station with current version 1.3.7. Upgrade the station's firmware to 1.3.8 or later.	Troubleshoot Remove
---------	---	---------------	---	------------------------

- It is impossible to establish a connection with charging station. Try to perform a manual installation (see [chapter 3.6.5](#)) or perform a back to factory of the charging station.

Error	Schneider Electric EVLink Pr... SN: R23054000005	192.168.0.10	Information Error during last saving/discovering. Please redo last action	Troubleshoot Remove
-------	---	--------------	--	------------------------

- Charging station is newly discovered and ready to be installed into EcoStruxure EV Charging Expert.

New station	Open OCPP Open OCPP cha... SN: A11223344004	DHCP A11223344004 192 . 168 . 0 . 150	TRI123	A11223344004
-------------	--	---	--------	--------------

- Charging station already installed into EcoStruxure EV Charging Expert.

Installed	Open OCPP Open OCPP cha... SN: A11223344001	DHCP A11223344001 192 . 168 . 0 . 150	TRI123	A11223344001 1st Floor - South
-----------	--	---	--------	-----------------------------------

3.6.4 Charging station configuration

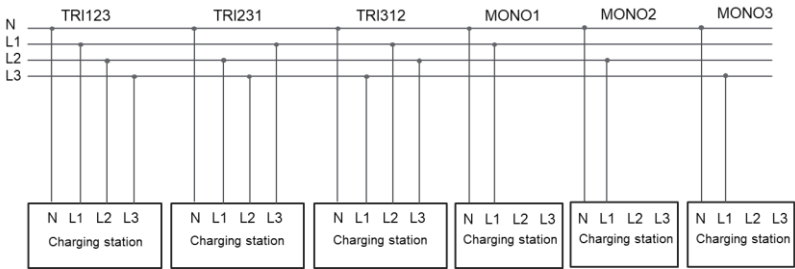
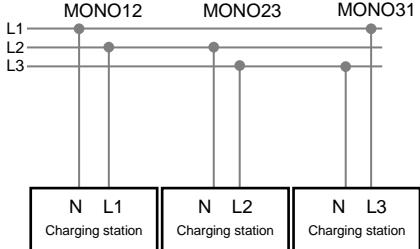
Steps	Description
1	Click on  to discover new charging station to install and present into the network
2	Update charging station settings: <ul style="list-style-type: none"> • Station name: Select a name to identify your charging station. (max 30 characters) • IP Address: 2 options: <ul style="list-style-type: none"> ○ DHCP activated: Select DHCP if there is a DHCP server activated (in EcoStruxure EV Charging Expert or local network). ○ DHCP deactivated: Set IP address according to network architecture. • Connector(s): Select the phase wiring of each connector in charging station according to electrical cabling. <i>example for 3 x 400V with neutral:</i>  <i>example for 3 x 230 without neutral:</i>  <ul style="list-style-type: none"> • Box identity: If a supervision is activated, select the name configured by supervision to identify the charging station. Otherwise select a name to identify the charging station. • Zones: Zone assignment, see chapter 3.7.5
3	Advanced details and configuration: <ul style="list-style-type: none"> • Vendor: Charging station vendor • Serial number • Authentication group: Authentication group assignment, see chapter 3.11.1 • Version: Charging station firmware version • VIP Charging: Check the box to activate the VIP status of the charging station. Note: a VIP station status provides VIP privileges on load balancing. It means maximum energy will always be allocated to this station before the others. • Change password: when one password by station is selected, there is the possibility to add a password for each charging station with hexa or ascii format.

3.6.5 Manual charging station configuration

If a charging station is not detected automatically during scan, it is possible to declare it manually with OCPP or IP address (only for EVlink Pro AC, Schneider Charge Pro or EVlink City / Parking / Smart Wallbox).

3.6.5.1 OCPP configuration

To install a new charging station with OCPP, it is mandatory to first update charging station configuration:

- **Supervision URL:** add EcoStruxure EV Charging Expert URL. For unsecure connection:
 - ws://XXX.XXX.XXX.XXX:9979 – No security profile

For secure connection, add **OCPP certificate** (see [chapter 3.11](#)) and update supervision URL:

- wss://XXX.XXX.XXX.XXX:9980 – Activate security profile 0 with WebSocket secure.
- wss://XXX.XXX.XXX.XXX:9981 – Activate security profile 1.
- wss://XXX.XXX.XXX.XXX:9982 – Activate security profile 2.

Replace: XXX.XXX.XXX.XXX by EcoStruxure EV Charging Expert IP address.

- **Webserver certificate:** mandatory to get maintenance report and update charging station.

To complete the installation, please return to the installation page.

3.6.5.2 IP address configuration

Install a new charging station with IP address is available only for EVlink Pro AC, Schneider Charge Pro or EVlink City / Parking / Smart Wallbox. After clicking on +, a popup will appear to select the charging station model and IP address.

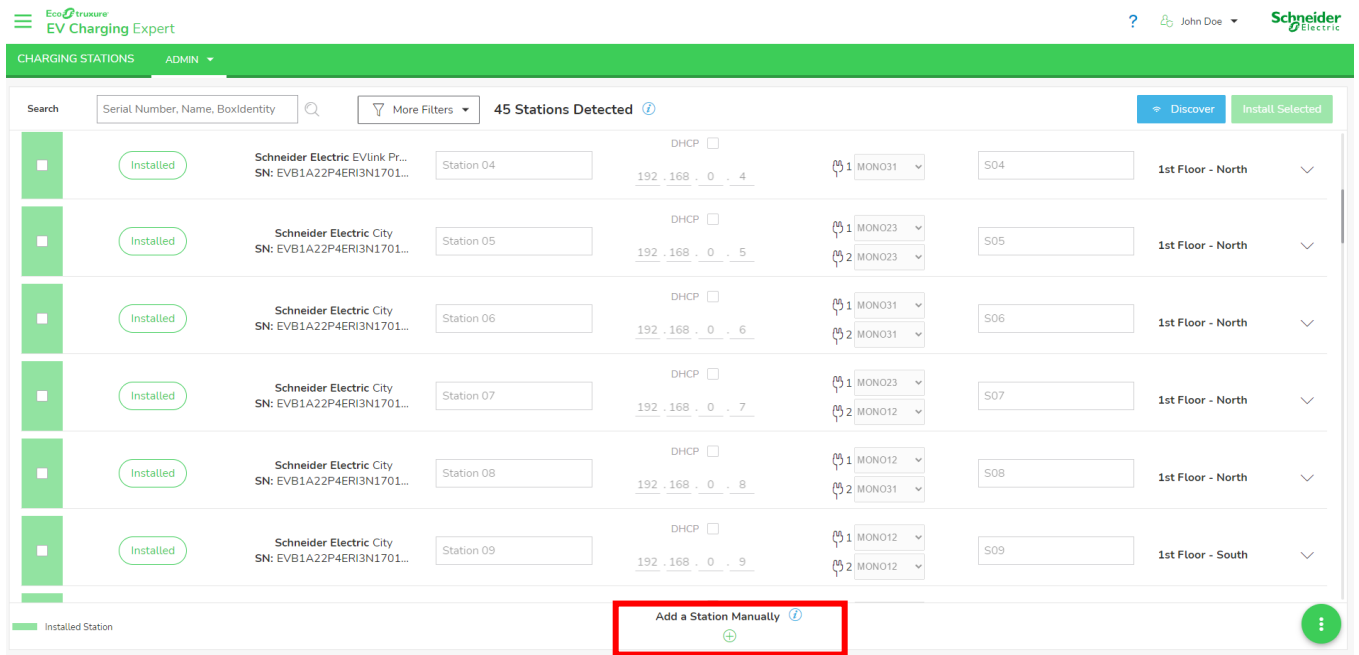

Once information is confirmed, to complete the installation, please return to the installation page to see charging station.

3.6.5.3 Get the serial number of a chaging station

For EVlink Parking, EVlink Smart WallBox and EVlink City it is mandatory to add **Serial Number**:

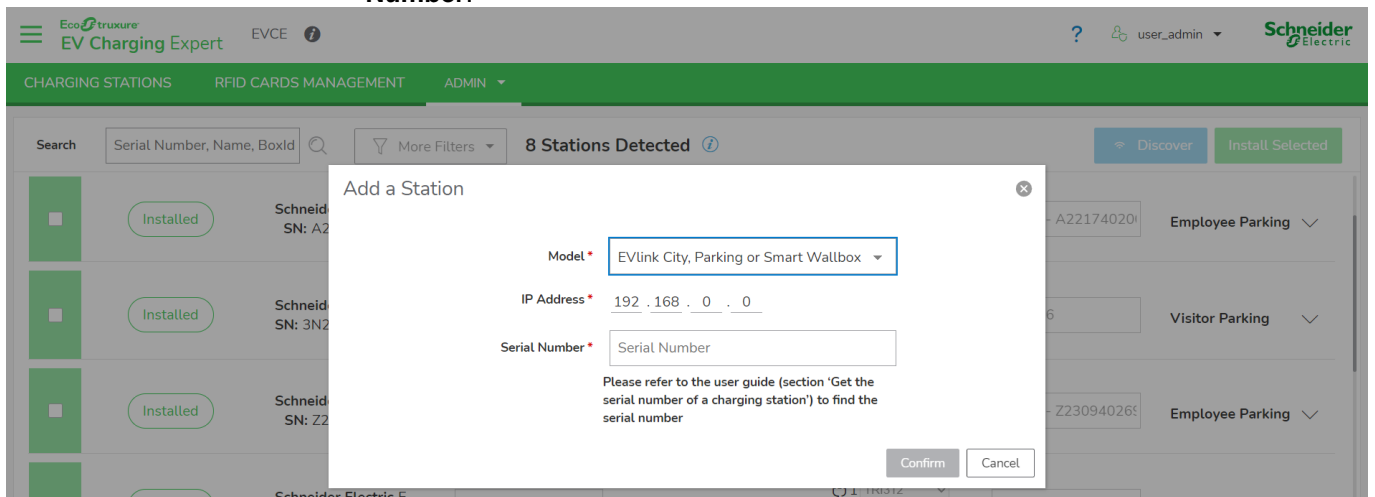

To add Serial number, it is necessary to connect to the webserver interface of the charging station : Maintenance > Report. The concatenation of Serial Number Part 1 & Serial Number Part 2 gives the serial number of the charging station.

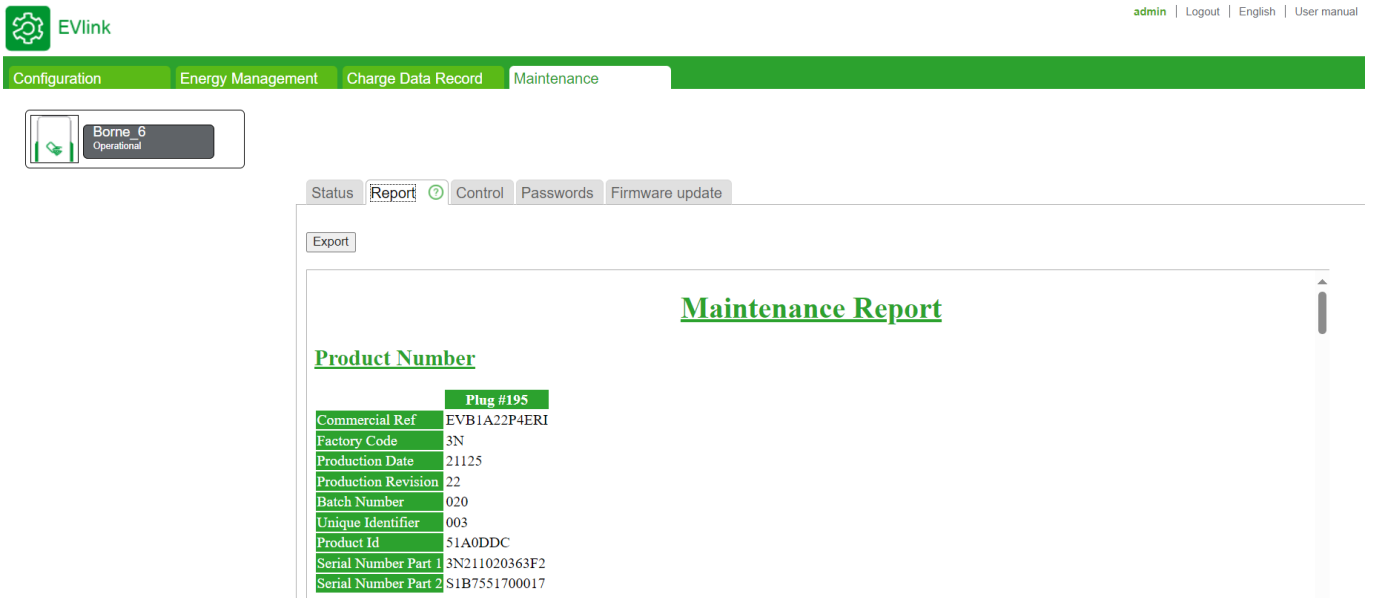

The screenshot shows the EVlink web interface. At the top, there is a navigation bar with tabs for Configuration, Energy Management, Charge Data Record, and Maintenance. The Maintenance tab is active. Below the navigation bar, there is a status indicator for 'Borne 6 Operational'. The main content area is titled 'Maintenance Report' and contains a table of product information.

Plug #195	
Commercial Ref	EVB1A22P4ERI
Factory Code	3N
Production Date	21125
Production Revision	22
Batch Number	020
Unique Identifier	003
Product Id	51A0DDC
Serial Number Part 1	3N211020363F2
Serial Number Part 2	S1B7551700017

ei. :

With this image above the concatenation of the serial number will be the following:
3N211020363F2S1B7551700017

3.7 Power meter configuration

Access by Admin tab → configuration → Power meters

3.7.1 Prerequisites

Power meters are only required in EcoStruxure EV Charging Expert dynamic mode. Ethernet connection must be configured (see [chapter 1.3.1.2](#)) regardless of the EcoStruxure EV Charging Expert and prior to the commissioning.

3.7.2 Manage Power Meters

Name *

RTU [?](#)

Model

IP Address * [?](#)

IP Port *

Slave ID *

Two options to connect power meter EcoStruxure EV Charging Expert:

- TCP: Connection is made directly with the product through the network. It is mandatory to provide the IP address and port of power meter.
- RTU: The connection is established directly with power meter using RS485 cable and USB adaptor. The power meter configuration should be:
 - **Baud Rate:** 19200 bits per second (bps). This determines the speed at which data is transmitted over the serial communication line.
 - **Data Bits:** 8. Each character is represented by 8 bits of data.
 - **Parity:** None. No parity bit is used for error checking.
 - **Stop Bits:** 1. One stop bit is used to signal the end of each character.

For both solutions, it's mandatory to select a supported model (see [chapter 1.1.1.8](#)) or customized model (see [chapter 3.6.3](#)). Power meter slave id matches the power meter Modbus configuration at this IP address (see [chapter 1.3.1.2](#)).

As soon as the power meter(s) are defined and updated, status column indicate connection status of device with EcoStruxure EV Charger Expert.

3.7.3 Define a new power meter model

Power Meters Manage Power Meters Define Power Meter Models Power Meter Configuration

Configure new power meter models Save Cancel Import Export

Power Meter Models

- pm5320
- iem3x5x
- Power Tag A
- NSX legacy
- NSX
- MTZ

+

Model Name: New Power Meter

Registers

RMS Current on Phase 1		RMS Current on Phase 2		RMS Current on Phase 3	
Address	1	Address	2	Address	3
Format	float32	Format	float32	Format	float32
Type	Holding Register	Type	Holding Register	Type	Holding Register
Scale Factor	1	Scale Factor	1	Scale Factor	1
Endian	Little Endian <input type="radio"/> Big Endian <input type="radio"/>	Endian	Little Endian <input type="radio"/> Big Endian <input type="radio"/>	Endian	Little Endian <input type="radio"/> Big Endian <input type="radio"/>
Active Power on Phase 1		Active Power on Phase 2		Active Power on Phase 3	
Address	4	Address	5	Address	6
Format	float32	Format	float32	Format	float32
Type	Holding Register	Type	Holding Register	Type	Holding Register
Scale Factor	1	Scale Factor	1	Scale Factor	1

1. Click on + to create a new power meter model.
2. Enter a name to the new model.
3. Fill the fields in each register:
 - Modbus register address
 - Format (float32, int64, int32, int16, uint64, uint32, uint16)
 - Type (Holding or Input register)
 - Scale factor. In case "Scale factor" is 1, values are expected as units:
 - Amps for current measurements (10 000 as RMS current with Scale factor 0.001 is considered as 10Amps)
 - kW for power measurements (1 000 as active power with Scale factor 0.1 is considered as 100kW)
 - kWh for energy measurements
4. Save the new power meter model.

3.8 Zone configuration

Access by the Admin tab → configuration → zone management

3.8.1 Prerequisites

At zone or subzone creation, it is important to define a maximum current limitation. To declare a zone as dynamic (for dynamic load balancing), simply assign a power meter to the electrical zone (configured power meter [chapter 3.6.2](#)).

3.8.2 Zone configuration

The screenshot shows the 'Zone Creation' interface in the EcoStruxure EV Charging Expert. The top navigation bar includes 'CHARGING STATIONS', 'SUPERVISION MANAGEMENT', and 'ADMIN'. Below this, a menu lists various configuration options, with 'Zone Management' highlighted. The main area is titled 'Zone Creation' and contains a table for managing zones. The table has columns for Name, Maximum Current, Power Meter, Energy Management Directive, Degraded Mode Zone Setpoint, and Power Meter (local prod). A 'Main zone' is currently configured with a maximum current of 70, a power meter of 'MainPowerMeter', and a degraded mode setpoint of 30. A green '+' icon is used to add new zones, and a 'Save All' button is located in the top right corner of the table area.

EcoStruxure EV Charging Expert can manage different zones and subzones based on the electrical architecture deployed in the installation. Please refer to [chapter 1.4](#).

3.8.3 Zone creation

Step	Comments
1	Click on + to create a zone.
2	Click on + next to Zone name to create a subzone .
3	Set the maximum current allowed in zone or subzone. Note: <ul style="list-style-type: none"> • The value must be lower or equal to the electrical capacity of the installation. • Max intensity in a sub-zone cannot be higher than the maximum intensity in the related zone.
4	To create a dynamic zone , select the power meter measuring the zone current. A power meter is assigned to a single zone and cannot be shared .
5	For the dynamic zone, set a Degraded Setpoint , it's used when the communication is lost with the power meter. <u>This corresponds to the amount of power that is always available for EV charging, irrespective of other electrical loads in the same zone.</u>
6	Only for local production, select the power meter measuring the local production energy. A power meter cannot be shared.

To delete an electrical zone, it is necessary to delete previously all charging stations assigned to this electrical zone.

3.8.4 Degraded Mode

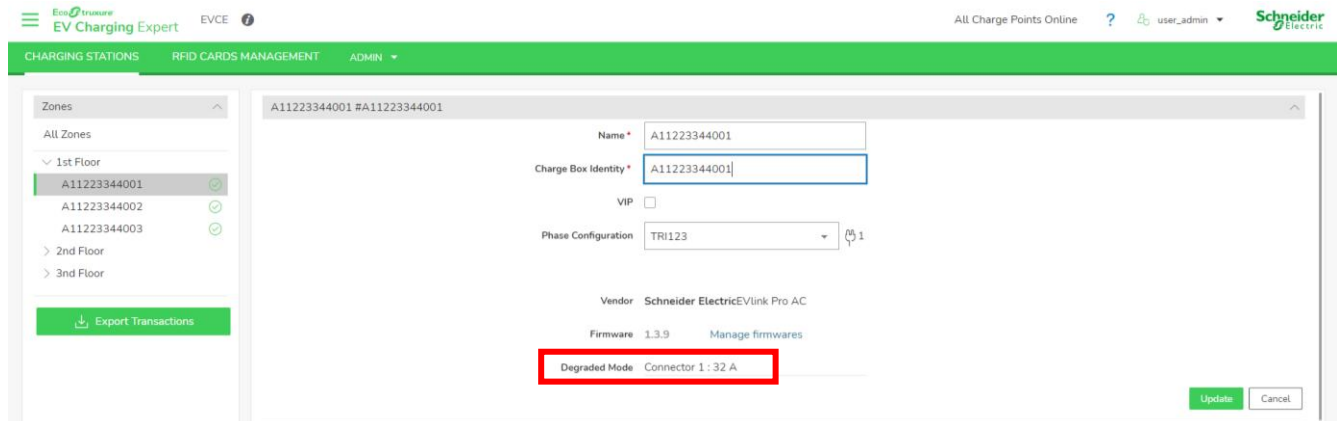

Degraded mode allows charging stations to continue charging, even if there is communication loss with EcoStruxure EV Charging Expert. For each charging station connector, an offline maximum current is calculated according to:

- Maximum current of static zone
- Degraded Mode Zone Setpoint of a dynamic zone (refer below)

For a dynamic zone, a **Degraded Mode Zone Setpoint** defines the maximum current that is always available for EV charging irrespective of other loads in same electrical zone. Ensure degraded mode zone setpoint defined for dynamic zone is enough to manage charging stations even if EcoStruxure Charging Expert loses building consumption information. For dynamic zone, offline management is active when communication is lost with charging station or power meter dedicated to the zone.

Examples:

Static zone:

Static zone characteristics:

- *Maximum current: 60A*
- *3 EVlink Pro AC (1 connector)*

Degraded calculation: $60/3 = 20$, for each connector 20A should be available even if connection is lost with EcoStruxure EV Charging Expert.

Static zone with reduction:

Static zone characteristics:

- *Maximum current: 60A*
- *3 EVlink Pro AC (1 connector)*
- *Reduction to 80% – Only 48A are now available.*

Degraded calculation: $48/3 = 16$, for each connector 16A should be available even if connection is lost with EcoStruxure EV Charging Expert.

Dynamic zone:

Dynamic zone characteristics:

- *Degraded Mode Zone Setpoint: 30A*
- *3 EVlink Pro AC (1 connector)*

Degraded calculation: $30/3 = 10$, for each connector 10A should be available even if connection is lost with power meter.

3.8.5 Charging station electrical zone assignation

To manage charging stations, it is required to assign charging stations to electrical zone previously configured. A station can be assigned only to a terminal zone (zone without subzone).

Configuration of stations per zone

Unassigned Stations

Device name	↑
<input type="checkbox"/> A11223344002	
<input type="checkbox"/> A11223344003	

1st Floor > 1st Floor - South
1st Floor - South

Chargers

Device name	↑	Box ID	↑
<input type="checkbox"/> A11223344001		A11223344001	

1st Floor - South

Chargers

Device name	↑	Box ID	↑
<input checked="" type="checkbox"/>			

No charger was assigned to this zone yet. Please move the chargers from an existing zone

To assign station in an electrical zone:

- Select multiple charging stations, click on **Move Selection To** and select an electrical zone.
- Click on charging station ⇒ and select an electrical zone.

3.9 Time Of Use

Access: Admin tab → Configuration → Time-of-use

3.9.1 Definition

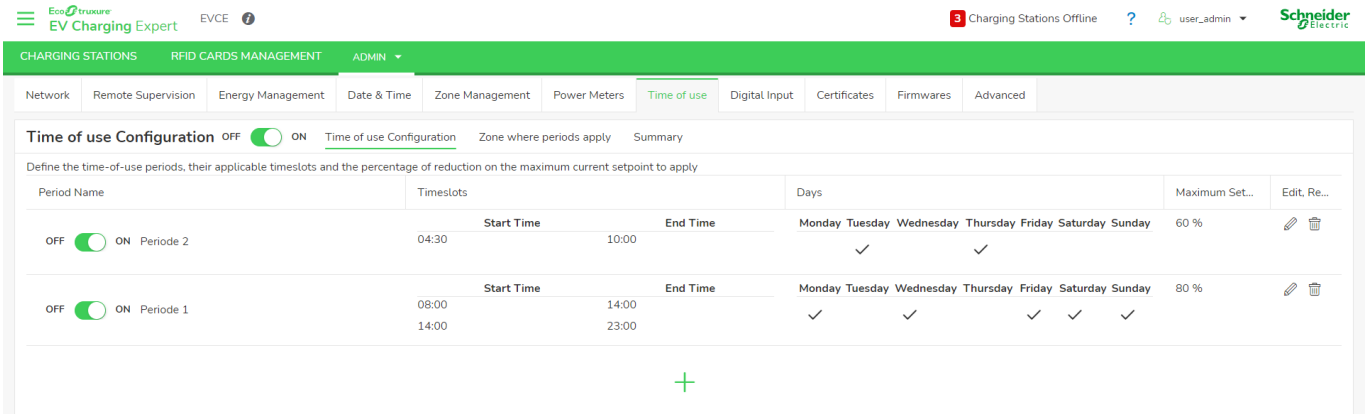

Use Time Of Use (TOU) configuration to reduce the power capacity per zone depending on day/time to match the local tariff policy.

A total of 5 periods and 20 timeslots can be configured. A period is defined by:

- **Days:** Selected days where timeslots are applied.
- **Timeslots:** Start and stop time when reduction is applied.
- **Reduction:** Ratio of the maximum current of a zone. For example, for a zone with a maximum setpoint of 100A, if a ratio at 80% is applied then the new maximum setpoint is 80A for the zone.

3.9.2 Prerequisites

At least one zone must be created (see [chapter 3.7](#)).

3.9.3 Time Of Use configuration tab

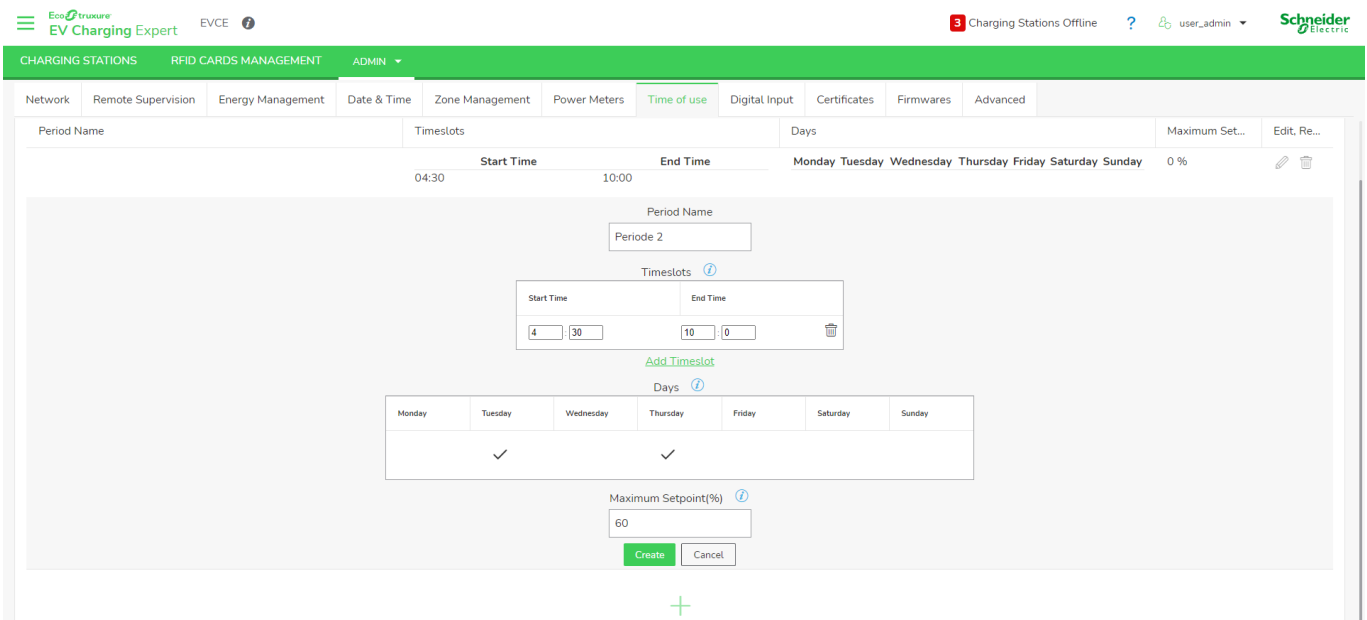

step	comments
1	Click on + icon to create a tariff period.
2	Enter period Name
3	Define Timeslots : <ul style="list-style-type: none"> • Start time • Stop time • Clicking on 'Add a timeslot' to add another timeslot for this reduction
4	Define Days when timeslots are applied
5	Define a ratio (percentage) of Maximum setpoint reduction

3.9.4 Zone configuration tab

For each reduction, it is possible to assign one or more periods to a zone.

3.9.5 Summary tab

Summary tabs displays maximum current reduction applied to each zone and period.

Zone	Nominal Current (A)	Current on "Periode 1" (A)	Current on "Periode 2" (A)
1st Floor	500	300	0
2nd Floor	500	500	500
3rd Floor	300	300	300

3.10 Digital Inputs

Access: Admin tab → Configuration → Digital Input

3.10.1 Definition

EcoStruxure EV Charging Expert digital inputs (DI) are provided through the external AP9811 digital input module. When a digital input is activated, the maximum zone current is reduced according to the configured settings.



3.10.2 Commissioning

Define the % to apply on maximum current setpoint based on the state of the digital inputs

# Digital Input	Name	Reduction	Edit
OFF <input checked="" type="checkbox"/> ON 1	low_limit	0 %	

Name *

Reduction * %

The digital input is provided through the AP9811 external digital input module, connected to EcoStruxure EV Charging Expert via USB. The module **supports one digital input**, which can be activated or deactivated.

Settings:

- **Name**
- **Maximum Setpoint:** Reduction (percentage) applied to EcoStruxure EV Charging Expert zones when the digital input is active.

3.10.3 Electrical connection

The digital input is provided by the AP9811 USB module. To activate the digital input, a dry-contact closure between COM and the Input terminal NC is required.

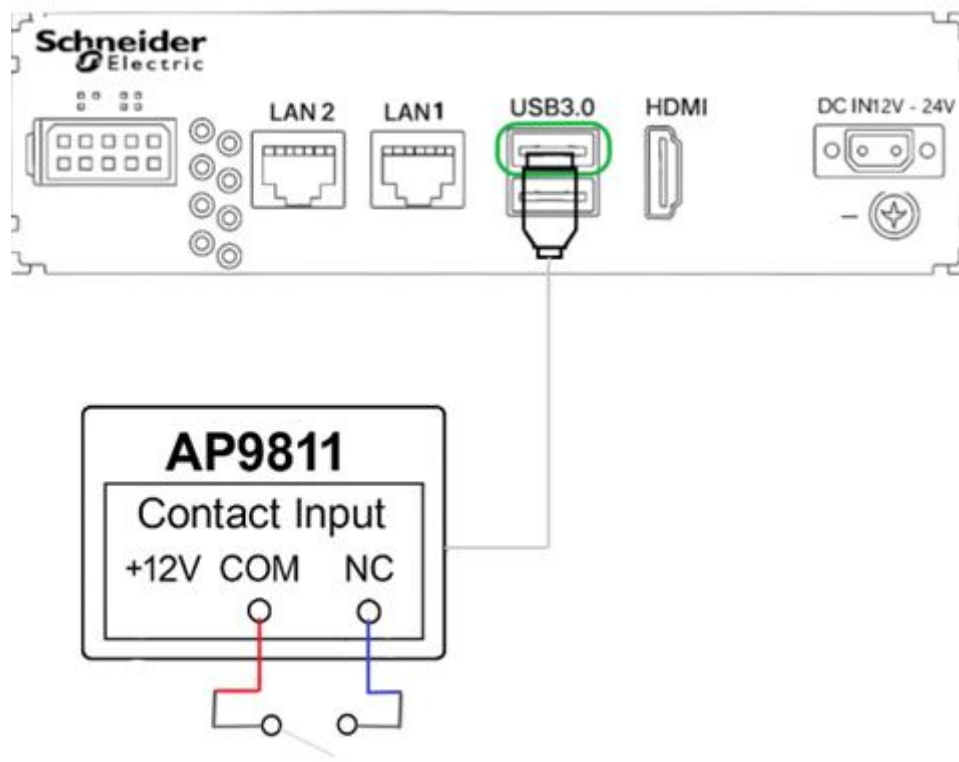

⚠ CAUTION

In case of AP9811's USB module disconnection, a warning is displayed in the user interface and the reduction is not applied while the device is not reconnected.

3.11 Local authentication management

When there is no configured supervision, the EcoStruxure EV Charging Expert offers the possibility to manage authentication strategy to grant access to the charging stations.

The RFID cards management feature is made of two parts:

- Authentication groups of chargers
- RFID cards

3.11.1 Authentication group

An authentication group is a selection of charging stations associated with a list of RFID cards. Each authentication group has its own online and offline authentication strategies.

Each charging station can only be associated with a single authentication group when RFID cards can be assigned to several groups (see [chapter 3.11.2](#)).

3.11.1.1 First installation

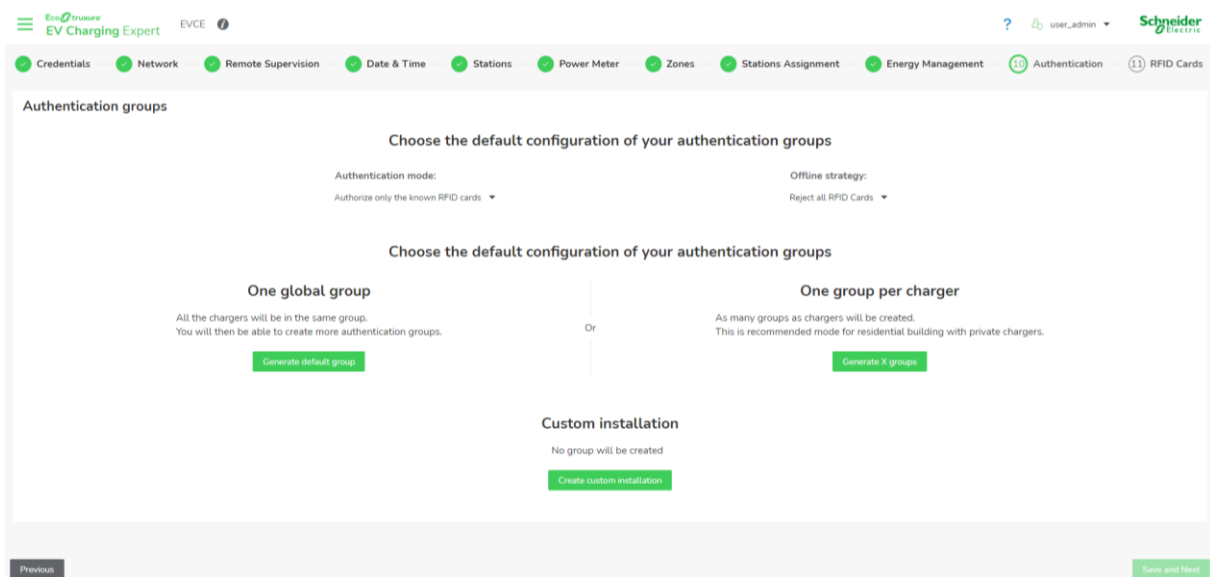

At first installation, three options are proposed:

- One global group: All installed chargers will be assigned to one authentication group.
- One group per charger: An authentication group is created for each charging station (best solution to manage one RFID badge for one charging station).
- Custom installation: Create one or multiple authentication groups according to installation needs.

After configuration, it is possible to change authentication configuration from **Admin** panel.

3.11.1.2 Authentication group management

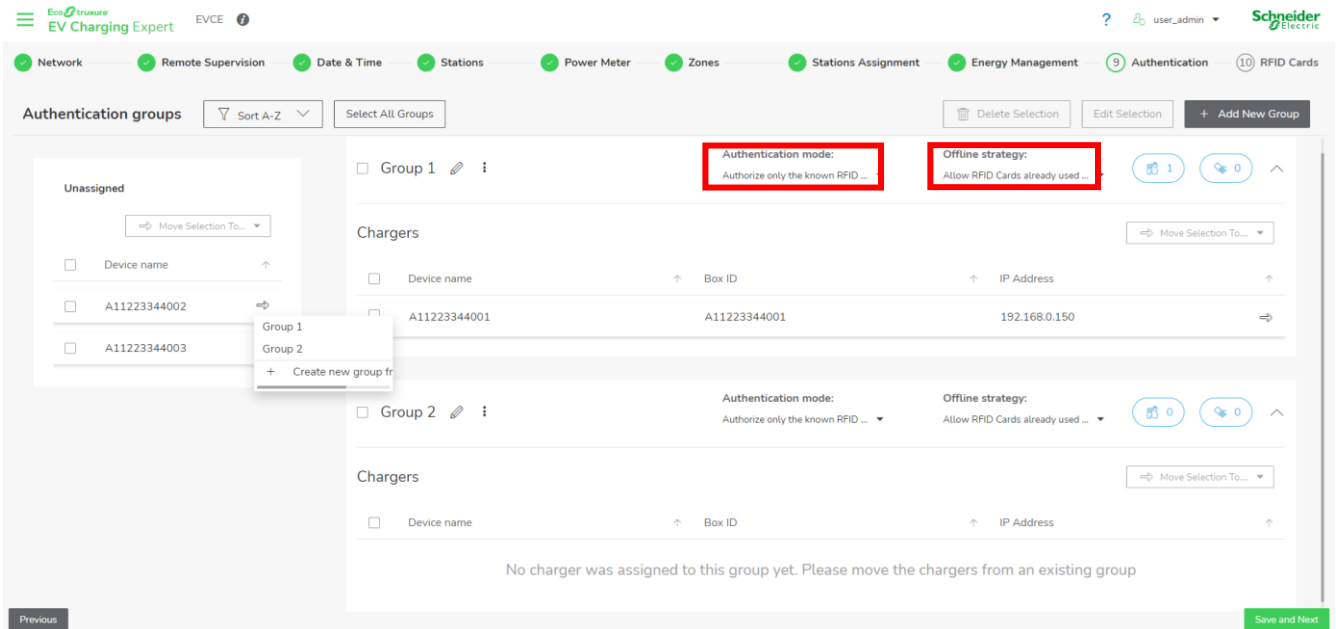

In authentication group management, **online** and **offline** authentication strategies are defined.

About **Authentication mode**:

- **Authorize all RFID cards**: Charging station starts a transaction only if EV driver uses a RFID card on the charging station (whatever is RFID).
- **Authorize only the known RFID cards**: Charging station starts a transaction only if EV driver uses a RFID card known by EcoStruxure EV Charging Expert.
- **Disable RFID card reader**: Charging station starts a transaction when EV is plugged without any other action.

About **Offline strategy**, the charging station disconnected from EcoStruxure EV Charging Expert behaves as below:

- **Authorize all RFID cards**: Charging station starts a transaction only if EV driver uses a RFID card on the charging station.
- **Reject all RFID cards**: No transaction is allowed when charging station is disconnected from EcoStruxure EV Charging Expert.
- **Using cache**: Offline charging station starts a transaction only if RFID card was already used on the charging station when it was online and accepted by EcoStruxure EV Charging Expert.

3.11.2 RFID cards

The screenshot shows the 'RFID Card Management' interface. At the top, there are navigation tabs for Network, Remote Supervision, Date & Time, Stations, Power Meter, Zones, Stations Assignment, Energy Management, Authentication, and RFID Cards. Below the tabs, there are buttons for '+ Add an RFID card', 'Import', and 'Export'. A table lists two RFID cards:

Id	VIP	Authorized	Comments	Registration	Last Time Seen	Authentication group
E6654ASXF651G	<input checked="" type="checkbox"/>	<input checked="" type="checkbox"/>	Card A	11/07/2024, 15:13:36	11/07/2024, 15:13:36	Group 1
E6716CW6514DA	<input type="checkbox"/>	<input checked="" type="checkbox"/>	Card A	09/07/2024, 16:37:54	09/07/2024, 16:37:54	Select options

The 'Bulk Modifications' dropdown menu is open, showing a search bar and two options: 'Group 1' and 'Group 2'. The interface also includes a 'Previous' button and a 'Save and Finish' button.

3.11.2.1 Add RFID card

In the EcoStruxure EV Charging Expert, a RFID card is added with below details:

- **VIP:** Provide VIP privileges, EV driver will have priority in load management system. Disabled by default.
- **Authorized:** Authorize EV driver to start a transaction with this RFID card. Only used for assigned authentication group with **Authorize only the known RFID cards** authentication strategy. Unauthorized by default.
- **Name:** Associate a name to a RFID card.
- **Comments:** Associate a comment to a RFID card.
- **Authentication group:** Assign a RFID card to one or more authentication groups (see [chapter 2.9.1.2](#))

3.11.2.2 Import/Export RFID card

RFID cards list can be exported or imported from web interface. The file format supported by EcoStruxure EV Charging Expert is a CSV file with 4 columns:

- **id_tag:** String type, that corresponds to RFID card information.
- **is_blocked:** Integer type (only 0 and 1 value accepted), that corresponds to authorize (0) or not (1).
- **vip_level:** Integer type (only 0 and 1 value accepted), that corresponds to VIP activation (1) or VIP deactivation (0). A VIP badge gets priority on power allocation before the other charging stations.
- **name:** String type, that correspond to the name associated to the RFID card.
- **comments:** String type, that corresponds to comment associate to RFID card.

CSV file example:

```
id_tag;is_blocked;vip_level;name;comments
E6716CW6514DA;0;0;Name A;Card A
E6654ASXF651G;0;1; Name B;Card A
```

NOTICE**IMPOSSIBLE TO IMPORT RFID CARD LIST FROM ECOSTRUXURE EV CHARGING VERSION BELLOW 6.0.0.**

Export csv file from previous EcoStruxure EV Charging Expert version change the format to respect new format and import RFID card list.

Failure to follow these instructions can result in an impossibility recovery RFID card list.

The maximum of RFID card is 10000.

3.12 Certificates

Access by Admin tab → Configuration → Certificates

3.12.1 Manage Certificates

The screenshot shows the 'Manage Certificates' page in the EcoStruxure EV Charging Expert interface. The page is titled 'Certificates' and includes a sub-header 'Manage Certificates' and 'OCPP & Webserver certificates'. The main content is a table of certificates with the following columns: Id, Name, Subject, and Expires on. Each row has a checkbox on the left and a 'built-in' button on the right. The table contains 8 rows of certificates.

Id	Name	Subject	Expires on
1	Amazon_Root_CA_1	C = US, O = Amazon, CN = Amazon Root CA 1	17/01/2038
2	GlobalSign_Root_CA	C = BE, O = GlobalSign nv-sa, OU = Root CA, C...	28/01/2028
3	QuoVadis_Root_CA_1_G3	C = BM, O = QuoVadis Limited, CN = QuoVadis ...	12/01/2042
4	CFCA_EV_ROOT	C = CN, O = China Financial Certification Autho...	31/12/2029
5	DigiCert_Global_Root_CA	C = US, O = DigiCert Inc, OU = www.digicert.co...	10/11/2031
6	DigiCert_Global_Root_G2	C = US, O = DigiCert Inc, OU = www.digicert.co...	15/01/2038
7	Entrust_Root_Certification_Authority_-_EC1	C = US, O = "Entrust, Inc.", OU = See www.entr...	18/12/2037
8	COMODO_RSA_Certification_Authority	C = GB, ST = Greater Manchester, L = Salford, ...	19/01/2038

Addition or deletion of certificates are allowed in **Manage Certificates** page. For instance, a new remote supervision certificate is uploaded in this bank of certificates to perform a WebSocket secure connection.

3.12.2 Device certificates

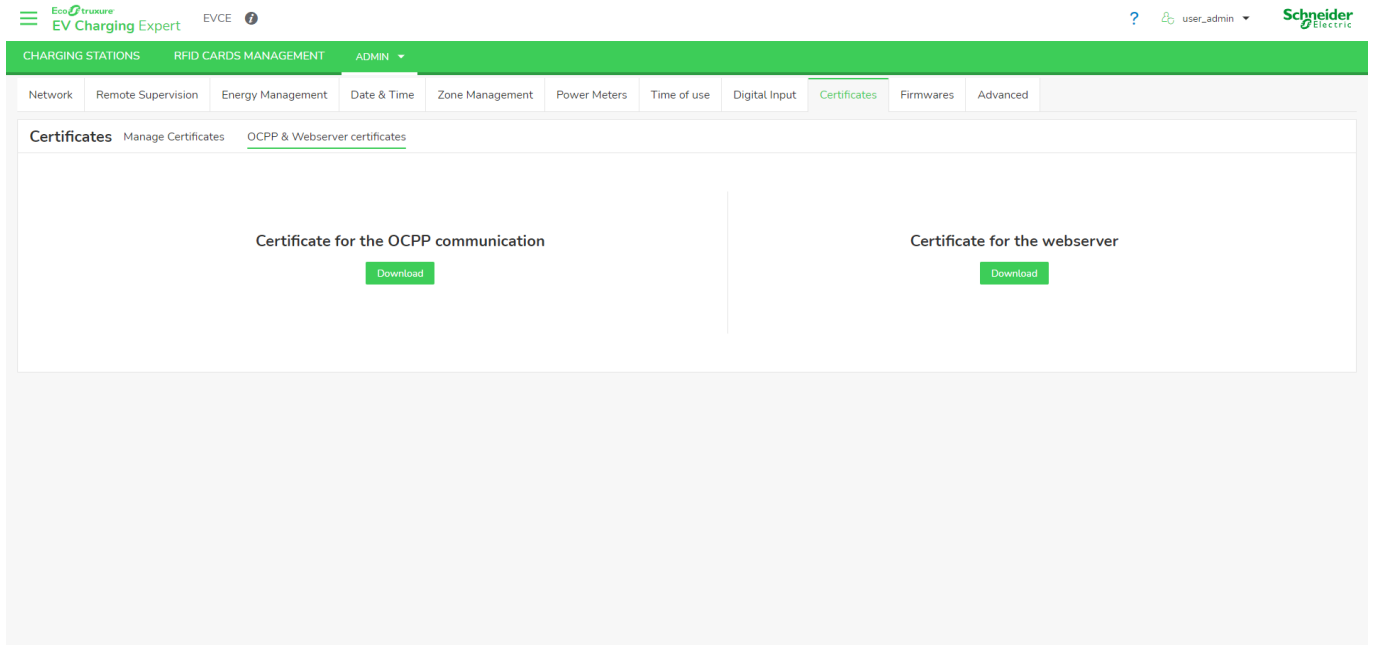

OCPP & Webservice certificates page provides EcoStruxure EV Charging Expert certificates to establish a secure communication between device and charging stations:

- **OCPP certificate:** This certificate is uploaded in the charging station to generate a WebSocket secure connection and manage charging station with OCPP security profiles 1 & 2.
- **Webservice certificate:** This certificate is uploaded in the charging station to establish a HTTPs connection and perform firmware update or get maintenance report in EcoStruxure EV Charging Expert.

3.13 Charging station firmware

Access by Admin tab → Configuration → Firmware

3.13.1 Manage charging station firmware

To update a charging station through EcoStruxure EV Charging Expert, it is required first to add its firmware file in local storage:

- Click on the **Add** button
- Add a firmware version
- Select the charging station model
- Choose the firmware file on your computer
- **Confirm** to start uploading the file into EcoStruxure EV Charging Expert.

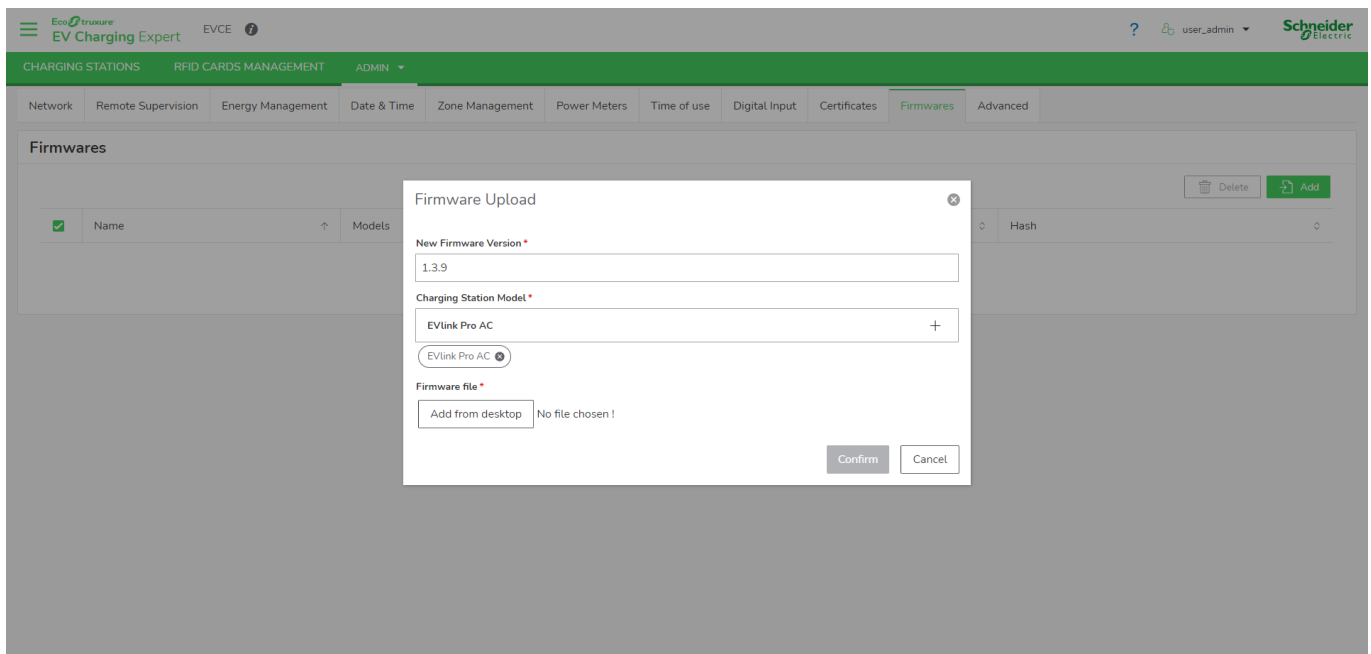

Upload progression is displayed as percentage. At the end of the upload, firmware status is displayed as **Available** (Ready for a firmware upgrade operation) or **Upload error** (impossible to upload the firmware file).

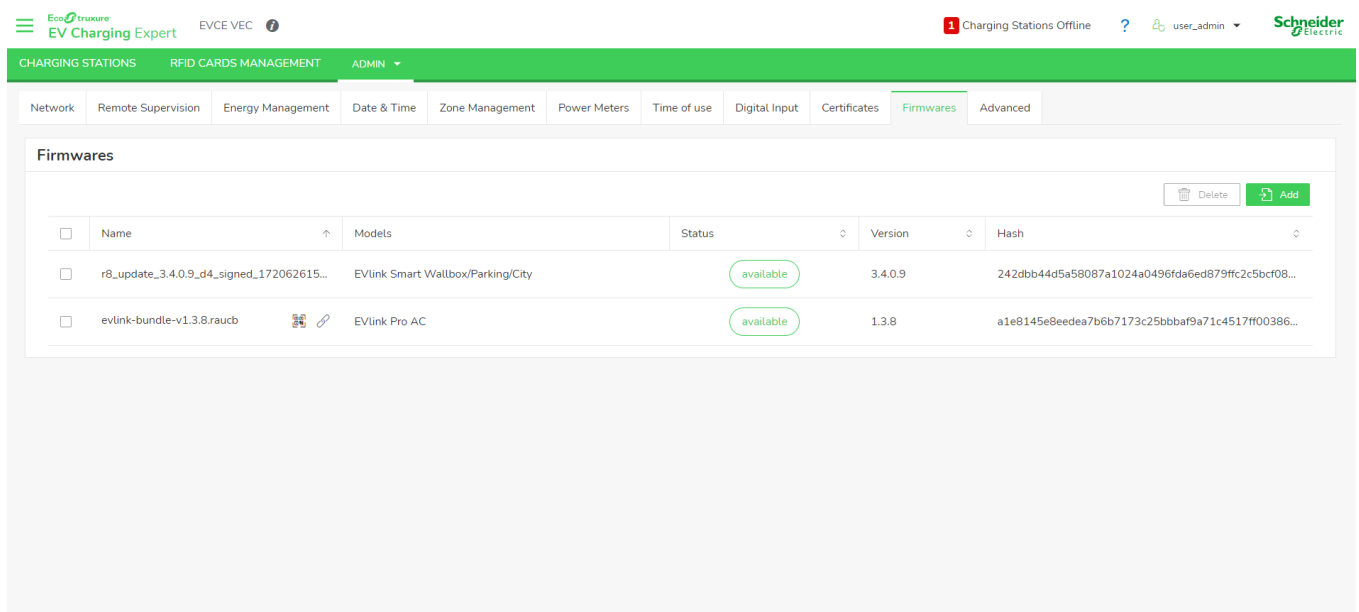



EcoStruxure EV Charging Expert doesn't accept more than one firmware per charging station model. There cannot be more than 6 firmware files at a time.

3.13.2 Internal HTTP server

EcoStruxure EV Charging Expert includes an internal HTTP server, allowing locally connected charging stations to be updated directly from an application or a monitoring system by copying the server URL link.

The URL link is available on firmware station management page and there are two options to get the URL link:

- QR code: 
- Copy/Past: 

It is also possible to manage HTTP unsecure server, see [chapter 3.14](#).

3.13.3 Perform charging station update

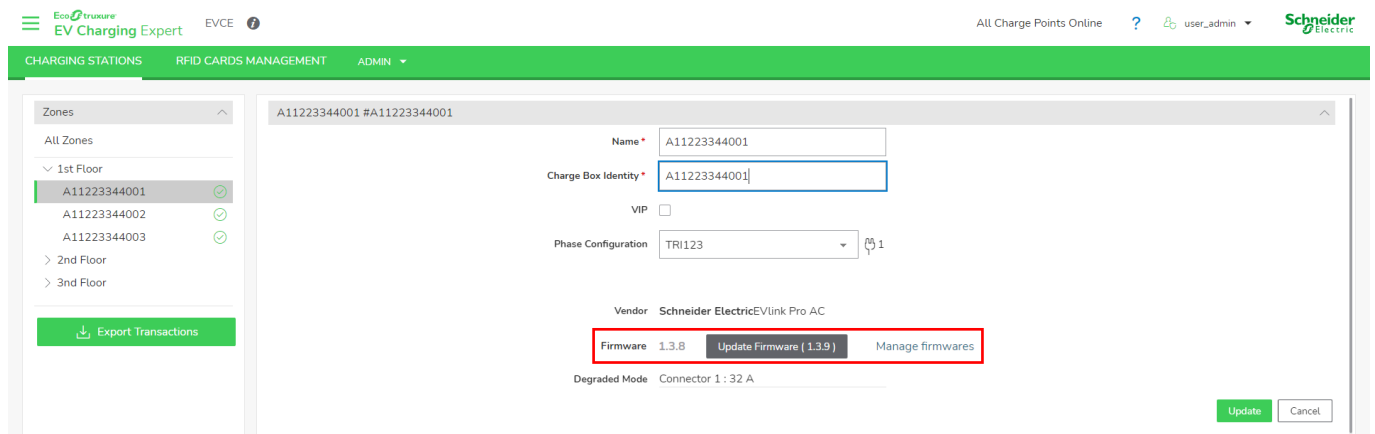

The screenshot displays the EcoStruxure EV Charging Expert interface. The top navigation bar includes 'CHARGING STATIONS', 'RFID CARDS MANAGEMENT', and 'ADMIN'. The main content area shows the configuration for a charging station with ID 'A11223344001'. The 'Firmware' section is highlighted with a red box, showing the current version '1.3.8' and an 'Update Firmware (1.3.9)' button. Other fields include 'Name', 'Charge Box Identity', 'VIP', 'Phase Configuration', 'Vendor', and 'Degraded Mode'.

When a new firmware version is available into EcoStruxure EV Charging Expert, **Update Firmware** button appears. The charging station can be upgraded to this new suggested version only when there is no transaction in progress.

3.14 Advanced configuration

Access by Admin tab → Configuration → Advanced

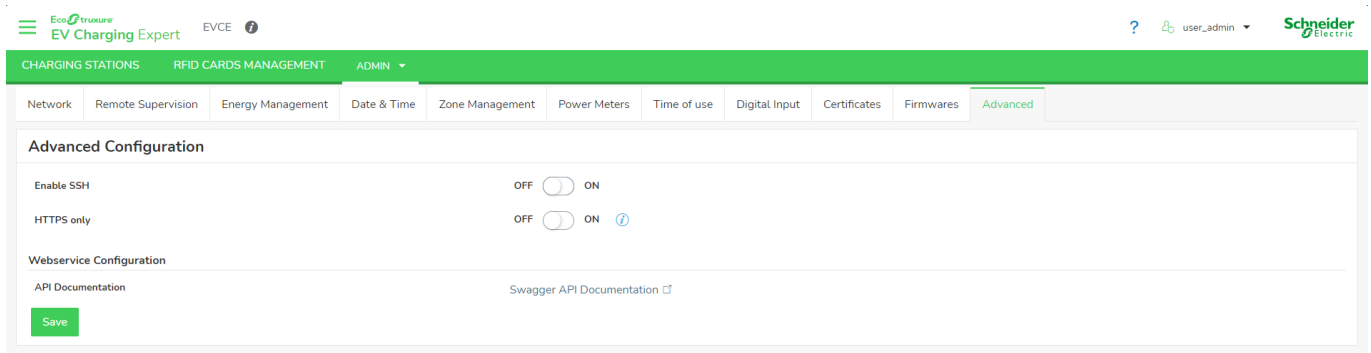

In this section are configured EcoStruxure EV Charging Expert advanced parameters related to SSH and access to API. API documentation is accessible as Swagger format to describe all possible commands to integrate EV charging infrastructure into an Energy or Building Management Software.

With **HTTPS only**, it is possible to deactivate HTTP server and manage EcoStruxure EV Charging Expert communication with charging station only in secure way.

For cybersecurity reasons, it is recommended to activate SSH only for maintenance purpose. Please contact Schneider Electric support prior to use this option.

3.15 User management

Access by the Admin tab → Users management

3.15.1 User management landing page

Username	Role	Date of Creation	Last Access
user_admin	admin	15/07/2024, 15:38:01	17/07/2024, 11:25:52
user_operator	operator	15/07/2024, 15:38:01	--

During the wizard, two default users are created (see [chapter 2.2](#)):

- Admin user
- Operator user

3.15.2 User addition

To create a user, click on **Add User** and fill below information:

- **New User Role:**
 - Admin: Manager of the installation. This role has access to all settings.
 - EBMS (Building Management System): Role used for Energy of Building Management Softwares, capable of managing charging stations directly through the REST API of EcoStruxure EV Charging Expert.
 - Operator: Role used for dashboard operations.
- **New Username**
- **New User Password / Confirm Password:** The password must be at least 12 characters long and must contain lowercase characters, uppercase characters, numbers, special characters (@\$!%?&)

3.15.3 Change the user password

The screenshot shows the 'User Management' page in the EV Charging Expert application. The user 'user_admin' is logged in. A dropdown menu is open, showing options: 'Change Language', 'Deutsch', 'English', 'Español', 'Français', 'Português', 'Change Password' (highlighted with a red box), 'Restart Assistant', and 'Logout'. The table below shows the user list:

Username	Role	Date of Creation	Last Access
user_admin	admin	15/07/2024, 15:38:01	17/07/2024, 11:25:52
user_operator	operator	15/07/2024, 15:38:01	--

A user can change webpage password anytime from personal menu.

3.15.4 Edit a user

Users can be edited from the user administration webpage, only accessible to administrators.

The screenshot shows the 'User Management' page in the EV Charging Expert application. The user 'user_admin' is logged in. A dropdown menu is open, showing options: '+ Add User', 'Refresh', 'Edit User', and 'Delete User'. The table below shows the user list:

Username	Role	Date of Creation	Last Access
user_admin	admin	15/07/2024, 15:38:01	17/07/2024, 11:25:52
user_operator	operator	15/07/2024, 15:38:01	--

3.16 Maintenance

3.16.1 Device logs

Access by the Admin tab → Logs

Date	Device	Type	Sub Type	Message
18/07/2024, 15:33:13	EVCE	Security	connection_success	Logon
18/07/2024, 15:31:04	EVCE	Security	connection_failure	Unknown
18/07/2024, 15:31:04	EVCE	Security	connection_failure	Unknown
18/07/2024, 15:31:04	EVCE	Security	connection_failure	Unknown
18/07/2024, 15:31:04	EVCE	Security	connection_failure	Unknown
18/07/2024, 12:00:09	EVCE	Time of use	Status	Period : P
18/07/2024, 09:44:07	EVCE	Stations maintenance	Restarting periodic generati...	86400s (
18/07/2024, 09:43:28	EVCE	Security	connection_success	Logon
18/07/2024, 09:43:21	EVCE	Security	connection_failure	Unknown
18/07/2024, 09:43:21	EVCE	Security	connection_failure	Unknown user

In log tab, all information related to security events, communication and load balancing are available. The logs can be filtered and exported according to charging stations, zones and log types.

EV Charging Expert can store up to 100,000 entries.

3.16.2 Device maintenance report

Access by the Admin tab → Device Report

EcoStruxure EV Charging Expert diagnostic is a file containing all information about the device (identification, firmware version, logs etc.).

3.16.3 Charging station maintenance report

Access by the Admin tab → Station reports

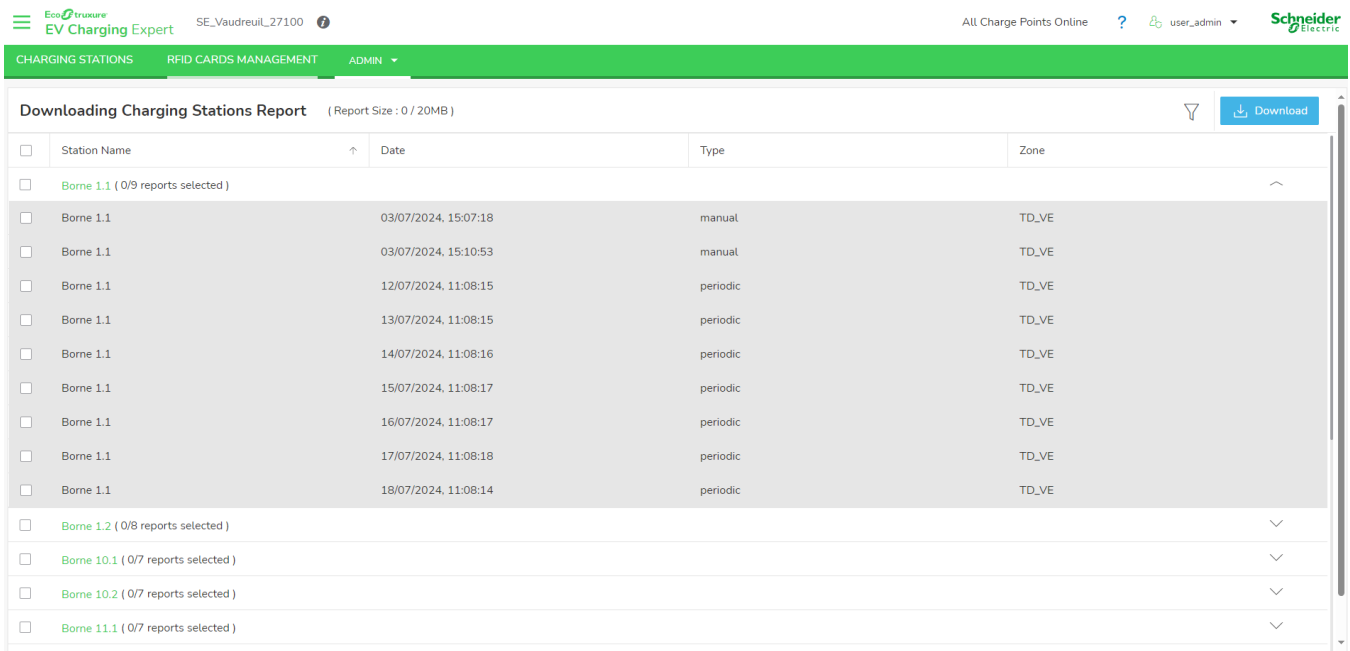

The screenshot shows the 'Downloading Charging Stations Report' interface. At the top, there is a navigation bar with 'CHARGING STATIONS', 'RFID CARDS MANAGEMENT', and 'ADMIN' tabs. The 'ADMIN' tab is active. Below the navigation bar, there is a header for the report download page, including a search icon and a 'Download' button. The main content area is a table with the following columns: Station Name, Date, Type, and Zone. The table lists reports for various charging stations, including Borne 1.1, Borne 1.2, Borne 10.1, Borne 10.2, and Borne 11.1. Each row has a checkbox for selection. The table is currently displaying reports for Borne 1.1, with 9 reports selected. Below the table, there are expandable sections for other stations: Borne 1.2 (0/8 reports selected), Borne 10.1 (0/7 reports selected), Borne 10.2 (0/7 reports selected), and Borne 11.1 (0/7 reports selected).

Station Name	Date	Type	Zone
Borne 1.1 (0/9 reports selected)			
<input type="checkbox"/> Borne 1.1	03/07/2024, 15:07:18	manual	TD_VE
<input type="checkbox"/> Borne 1.1	03/07/2024, 15:10:53	manual	TD_VE
<input type="checkbox"/> Borne 1.1	12/07/2024, 11:08:15	periodic	TD_VE
<input type="checkbox"/> Borne 1.1	13/07/2024, 11:08:15	periodic	TD_VE
<input type="checkbox"/> Borne 1.1	14/07/2024, 11:08:16	periodic	TD_VE
<input type="checkbox"/> Borne 1.1	15/07/2024, 11:08:17	periodic	TD_VE
<input type="checkbox"/> Borne 1.1	16/07/2024, 11:08:17	periodic	TD_VE
<input type="checkbox"/> Borne 1.1	17/07/2024, 11:08:18	periodic	TD_VE
<input type="checkbox"/> Borne 1.1	18/07/2024, 11:08:14	periodic	TD_VE
Borne 1.2 (0/8 reports selected)			
Borne 10.1 (0/7 reports selected)			
Borne 10.2 (0/7 reports selected)			
Borne 11.1 (0/7 reports selected)			

For each charging station with maintenance reports generation feature, EcoStruxure EV Charging Expert saves periodically a device report. From 5 to 10 periodic / manual reports can be stored. To generate a report manually, see [chapter 3.2.2](#).

To download device report, please select device reports and click on **Download**.

3.17 EV Charging Expert Firmware update

Access by hamburger menu → Firmware Update

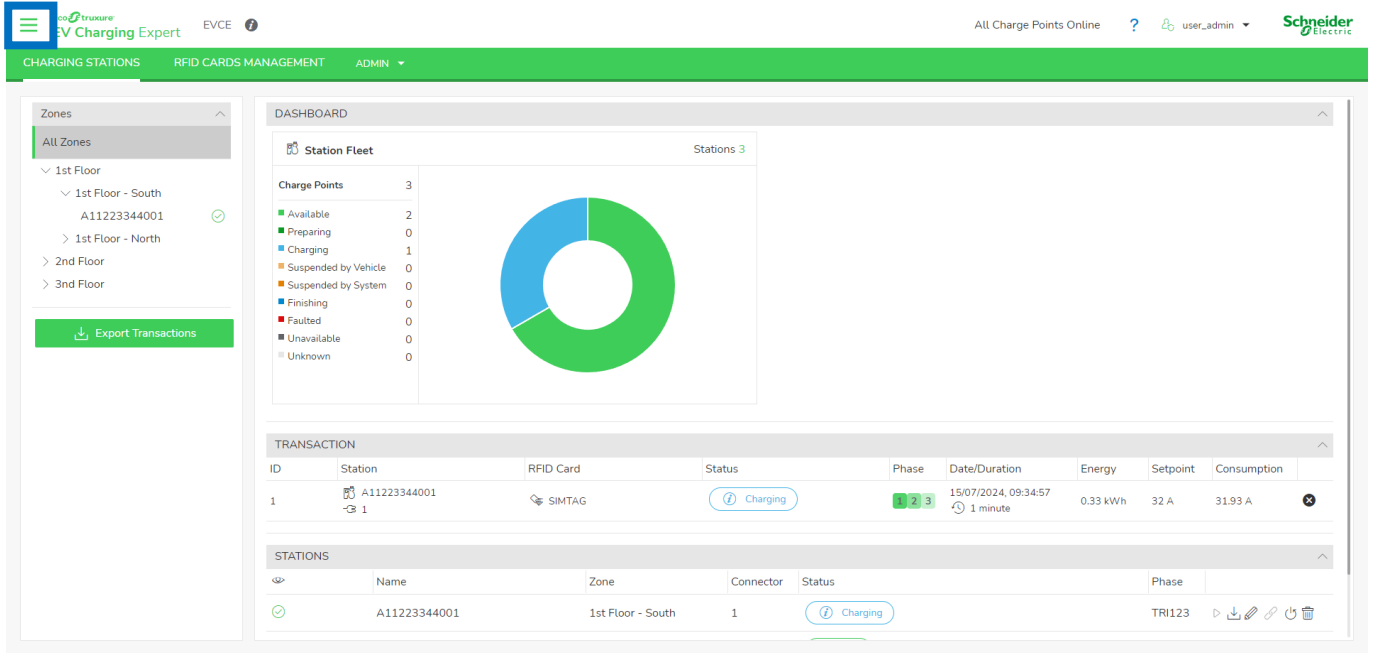

To upgrade EcoStruxure EV Charging Expert, select bundle from desktop. An update page appears while new version gets installed. Around one minute after the upgrade start, an automatic reboot happens to apply the new firmware.



3.18 License upgrade

EcoStruxure EV Charging Expert license can be upgraded for specific use cases. Please contact your Schneider Electric commercial partner.

Access by hamburger menu → License Update

EcoStruxure EV Charging Expert serial number is required to get an upgrade package. All information is present on license page and should be provided to Schneider Electric.

✕ Menu

- Licence Upgrade >
- Device Update >
- Back To Factory Settings >
- About >

User licence

Current licence

Reference Name: HMIBX1A0NEVB100SCP
Serial Number: 74fe48634732



100
Stations

20
Zones

4
Zone Levels



Local Production

Local CSMS

Add-on licences

Licence request

To request a new licence, please download a summary of your configuration using the Export button, then email the file to the address below. Schneider Electric support will provide a new file to upgrade your licence.

↓ Export
Request By Email 

Upload Licence Key

Add the licence key from your Desktop and click on Upload.

Add from desktop
↑ Upload

Description	Type	Reference	Validity
This is a base licence 2	base	HMIBX1A0NEVB100SCP	18/04/2050 ▼

Request By Email link will automatically open your email software and prepare a message with all required product information.

A license upgrade can:

- Add new models of charging stations.

3.19 Reboot and back to factory settings

Access by the Admin tab → Restart or Factory Reset

3.19.1 Reboot and back to factory settings from the webserver

When **Back To Factory Settings** is selected, all information stored into the EcoStruxure EV Charging Expert is erased. This action is irreversible.

When **Restart The Server** is selected, the EcoStruxure EV Charging Expert reboots. During the reboot, the communication with supervision and charging stations is lost.

3.19.2 Hardware back to factory settings

This procedure describes the steps to flash an EcoStruxure EV Charging Expert using industrial SD Card. This is the only procedure to run a complete reset of the product to version 6 and more.

3.19.2.1 Prerequisites

The following material is required:

- An SD Card of at least 8 GB (can be a microSD card with an SD card adapter)
- A Windows computer with an SD Card reader and administrative rights

3.19.2.2 SD Card preparation

The SD card / SD card adapter side latch should be “Unlocked” position:

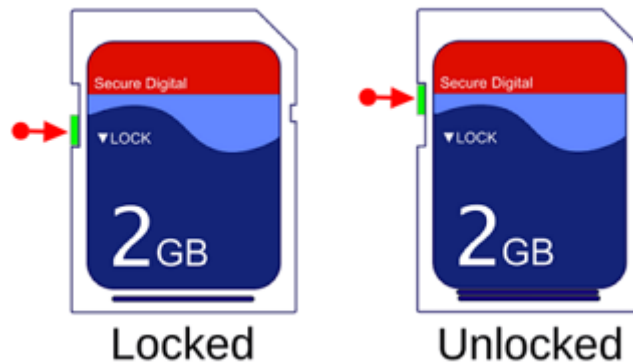

Plug the SD Card to the Windows computer using an internal SD card reader or an external USB SD card reader. Download Balena Etcher software from <https://etcher.balena.io/>

Install the downloaded software on your computer (administrative rights may be required). Launch the Etcher software:

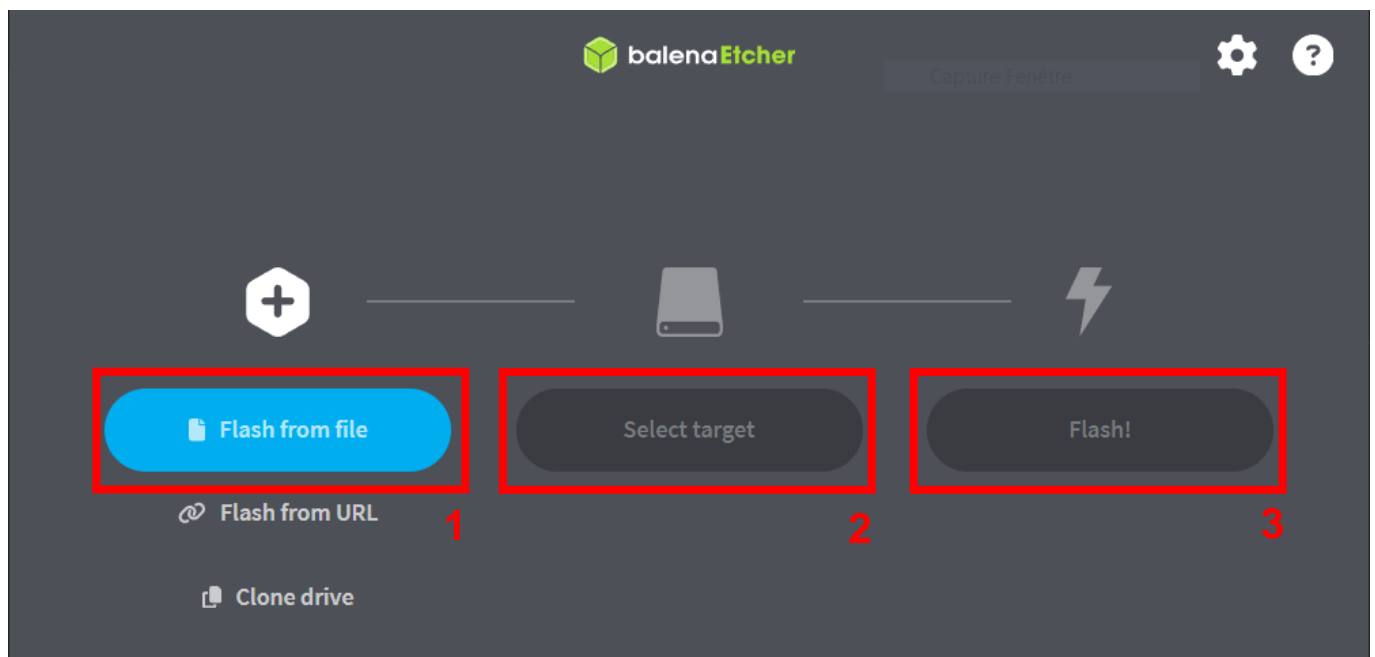

1. Download the EcoStruxure EV Charging Expert SD card back to factory image on se.com, click on “Flash from file” and select the image.
2. Click on “Select target” and select your SD card.

3. Click on "Flash". The SD card content will be erased and replaced by the EcoStruxure EV Charging Expert back to factory image. Wait for the Decompressing, Flashing and Verifying process to end with success.

At the end you should get the following message:

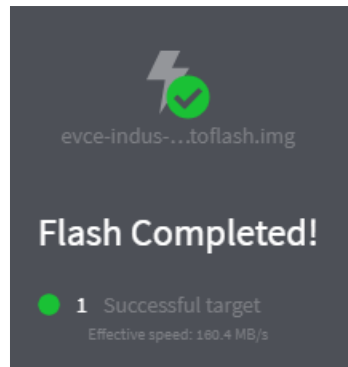

If you have an error, try again by using another SD card or another SD card reader.

3.19.2.3 Flashing the EcoStruxure EV Charging Expert

1. Unplug the device from power source.
2. Insert the prepared micro SD Card into the EcoStruxure EV Charging Expert micro SD card slot (see [chapter 1.1.1.6](#)).
3. Plug the device from power source.
4. During installation, LEDs 1, 2, 4 and 5 are blinking with a light chaser effect.
5. At the end of the installation, LEDs 3 and 6 are powered on and fixed.
6. Don't forget to remove the micro-SD Card and restart your device.

3.20 Save and Restore

3.20.1 Save configuration

Access by the Admin tab → Save

The EcoStruxure EV Charging Expert allows to save a backup of the current system configuration. This configuration can be imported later to automatically restore a lost configuration.

Configuration export content:

- Admin and user profiles credentials
- Charging stations configuration
- Zones configuration
- Power meters configuration
- Network configuration
- Authentication strategies
- List of RFID cards
- Authentication groups

When clicking **Save** button, a password and comment are required to generate the backup file. To guarantee the security of your information, exported file is encrypted and signed. It is strongly recommended to save the exported file in a safe repository.

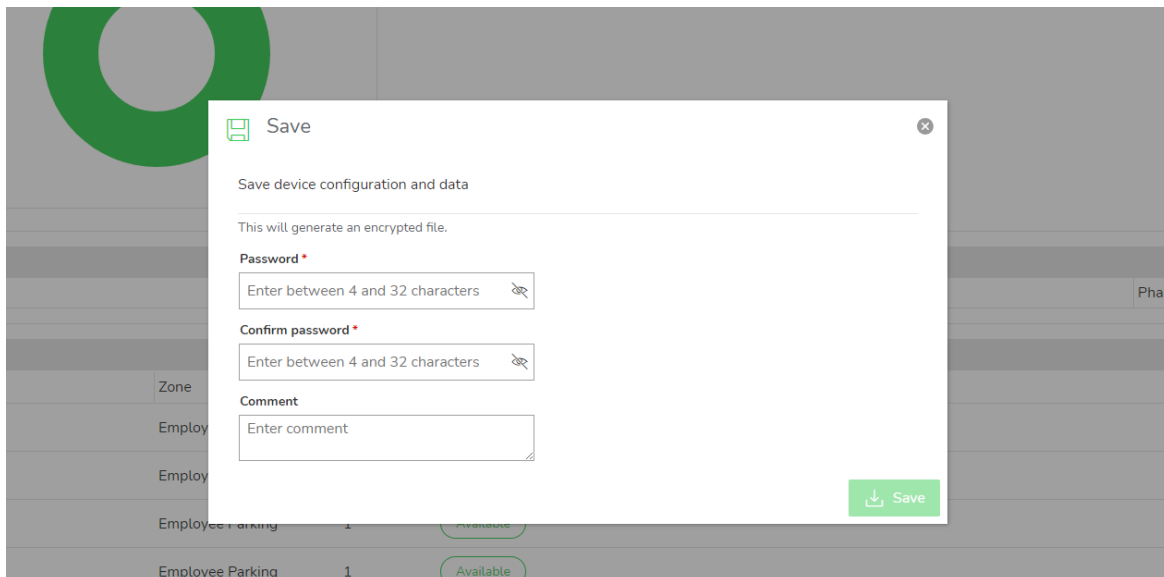

3.20.2 Restore configuration

Restore pop-up allows to recover a configuration from a previous configuration export. Only configuration file from version 6.0.0 or upper are compatible. Restoring the configuration requires the file password.

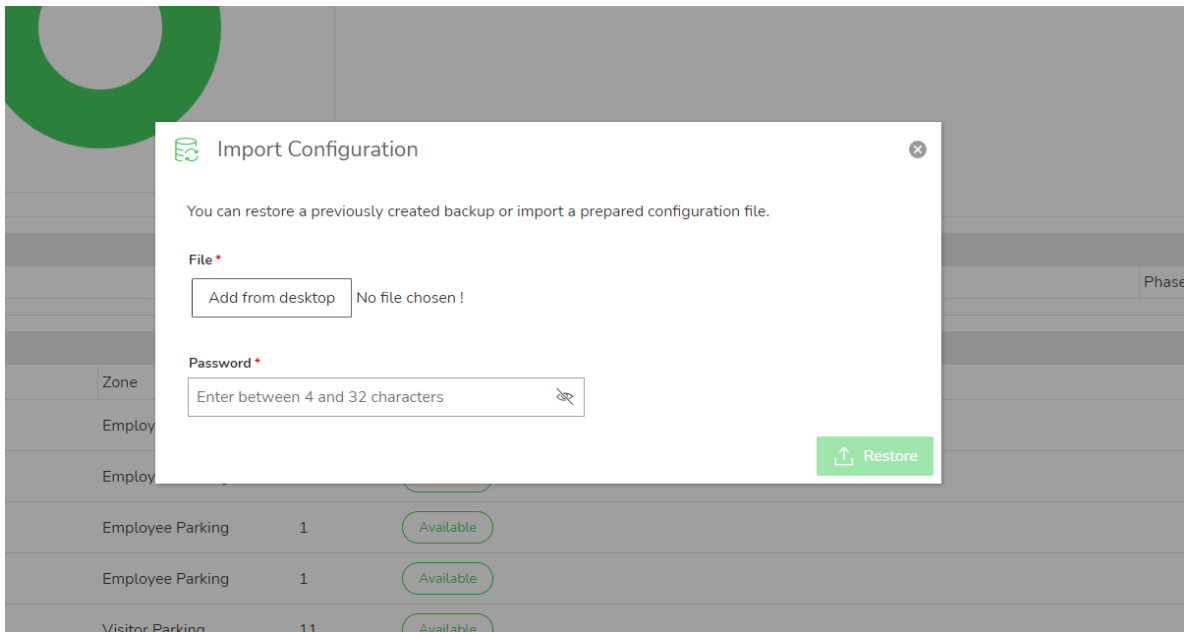

Chapter 4. REGULATORY INFORMATION



RCM certification

Schneider Electric Industries SAS

35, rue Joseph Monier
CS 30323
92506 Rueil Malmaison Cedex
France

www.se.com

DOCA0429EN© 2020 Schneider Electric. All rights reserved