

Schneider ID design  
scale 1:1  
units mm

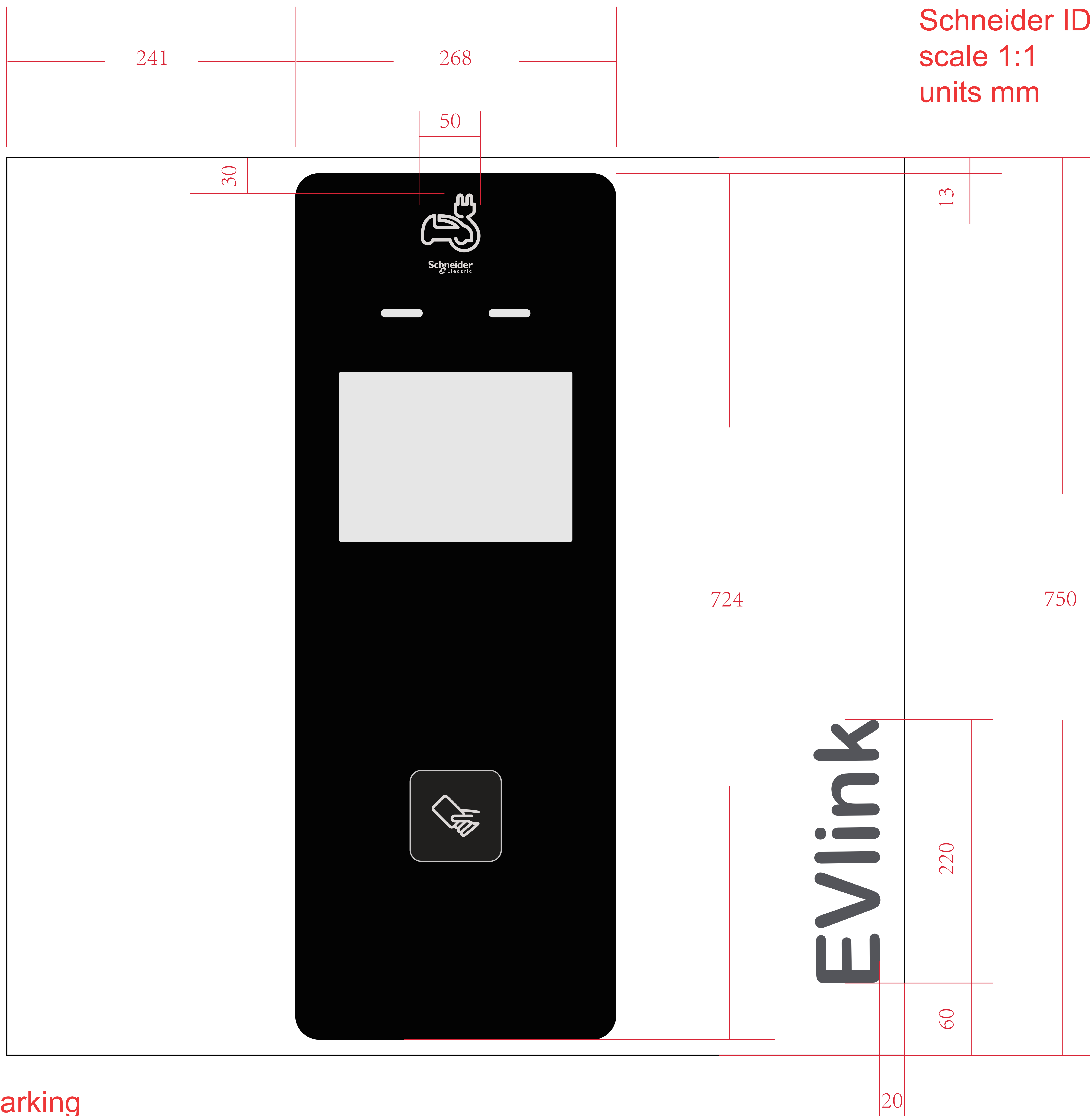

## Acrylic Marking



name: Border marking  
Process: Acrylic back screen printing,  
frame width 1mm  
colour: PT cool gray 1C

name: Swipe card marking  
Process: Acrylic back screen printing  
colour: Logo PT cool gray 1C  
Underpainting RAL 9005

Note: 1. Silkscreen processing in the middle black area,  
colour RAL 9005  
2. LOGO marking, colour PT cool gray 1C  
3. Swipe card marking, colour PT cool gray 1C  
4. EVlink marking, colour PT cool gray 11 C

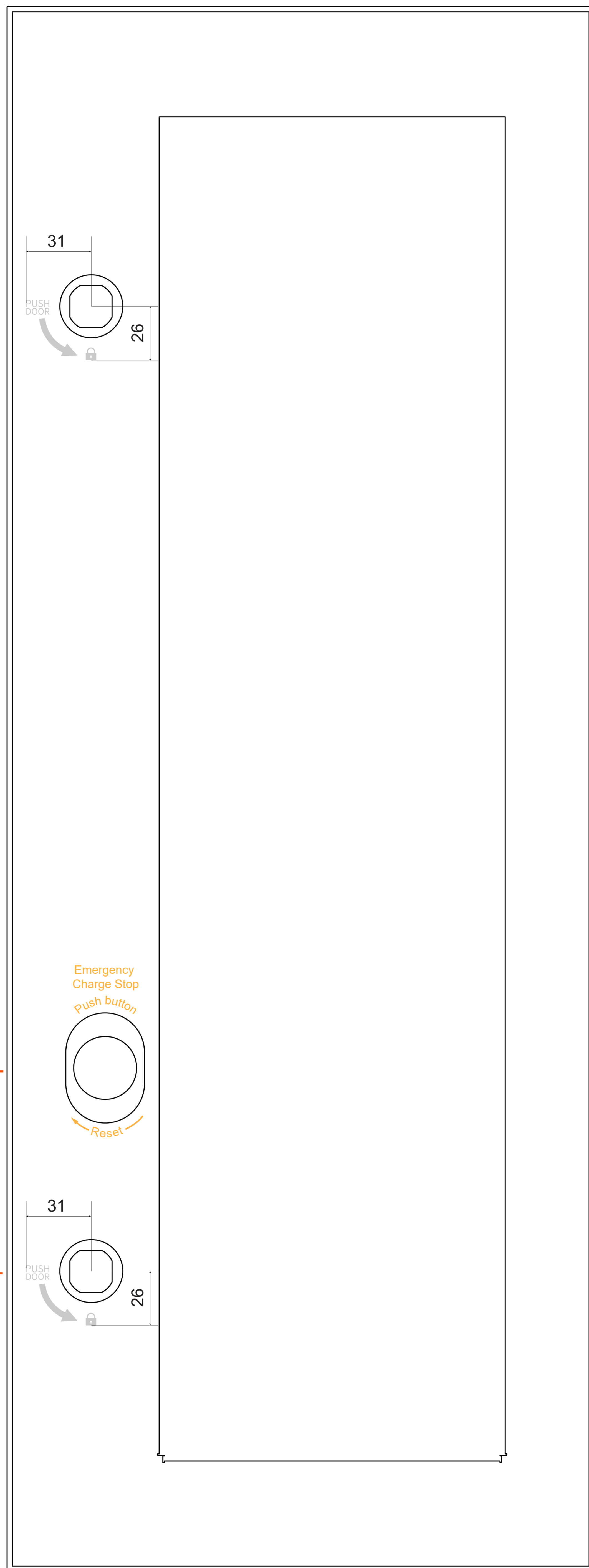

name: emergency charge stop  
colour: PT 143 C

name: Lock direction arrow  
colour: PT cool gray 3 C

Marking on the left door panel

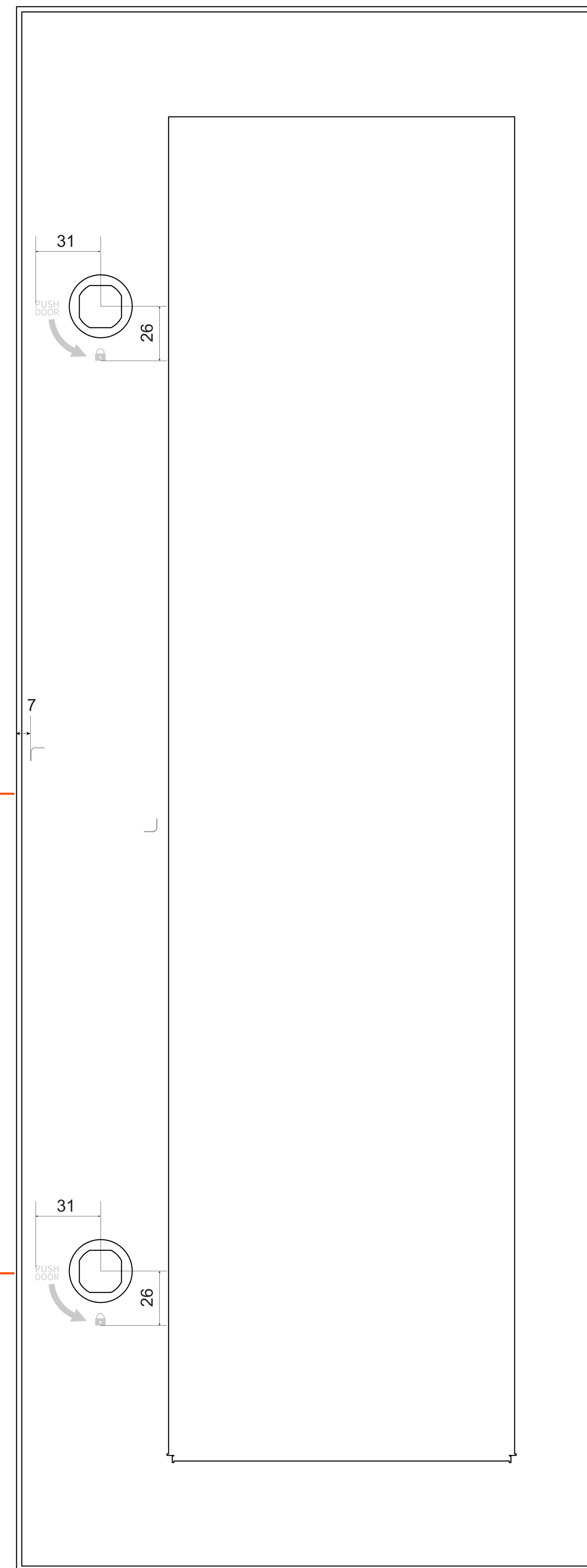

name: Marking of the label  
colour: PT cool gray 3 C

name: Lock direction arrow  
colour: PT cool gray 3 C

Marking on the right door panel

## Front marking on the left box

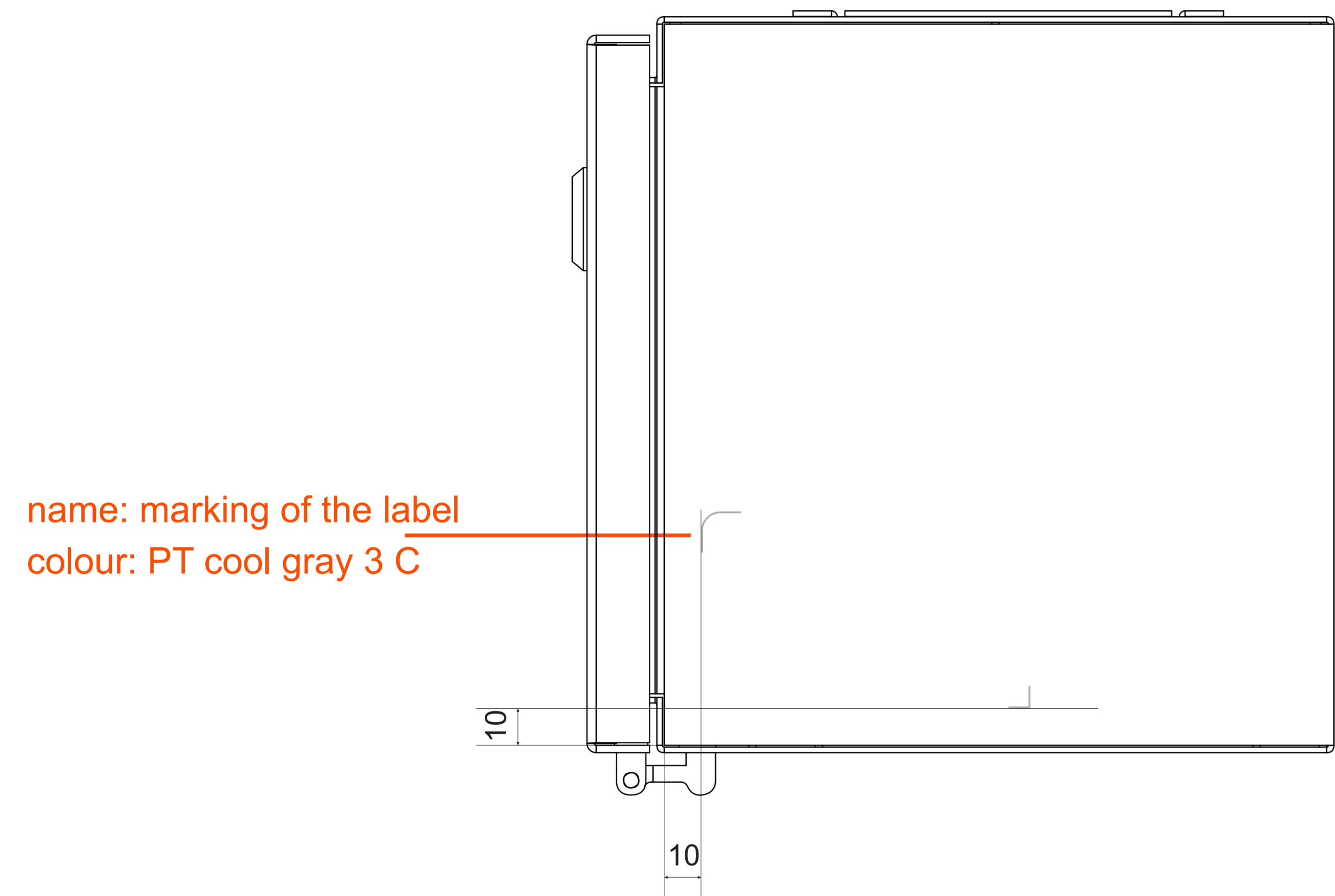

## Front marking on the meter box on the right

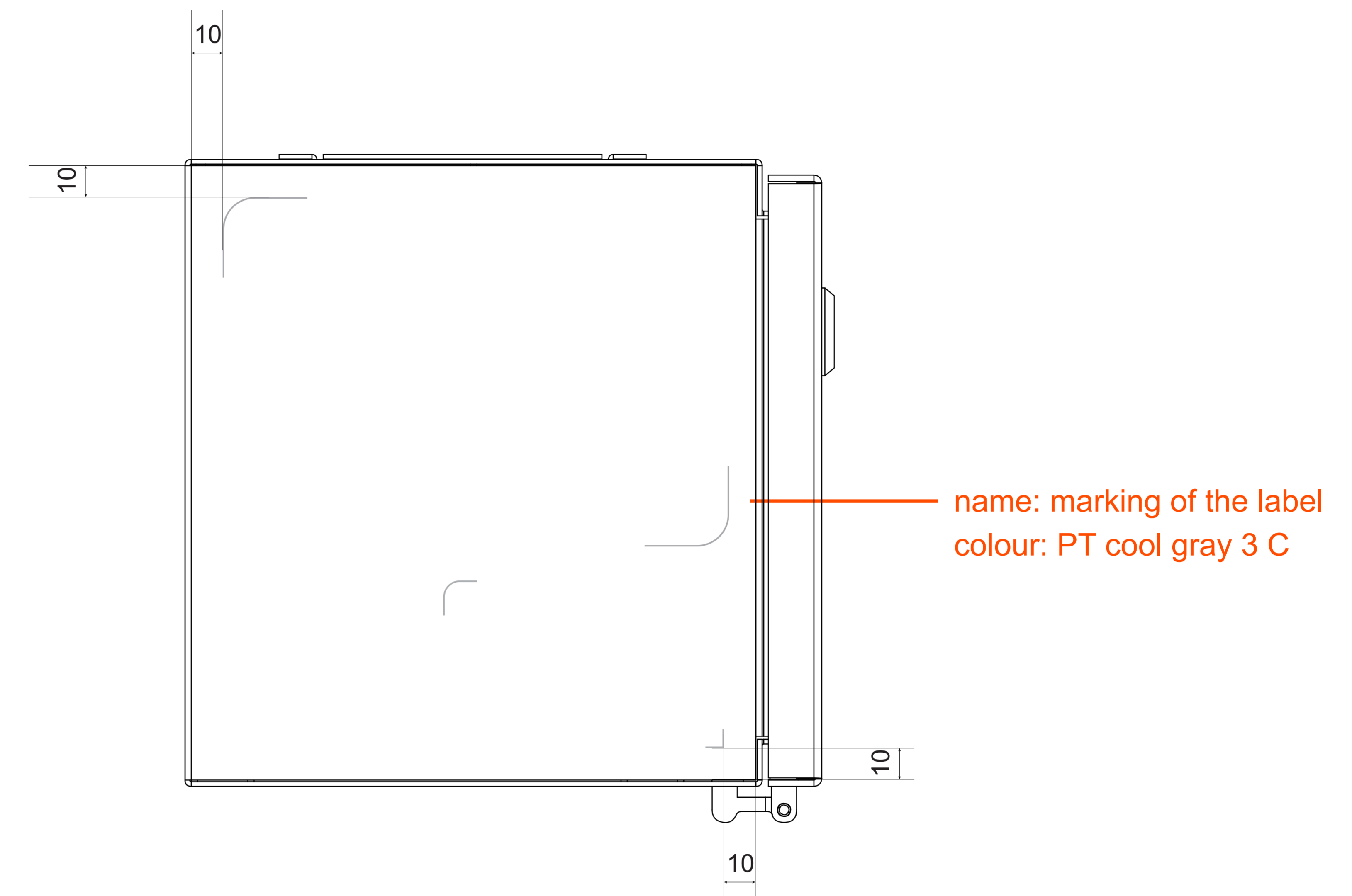

## Marking on the left side of the box

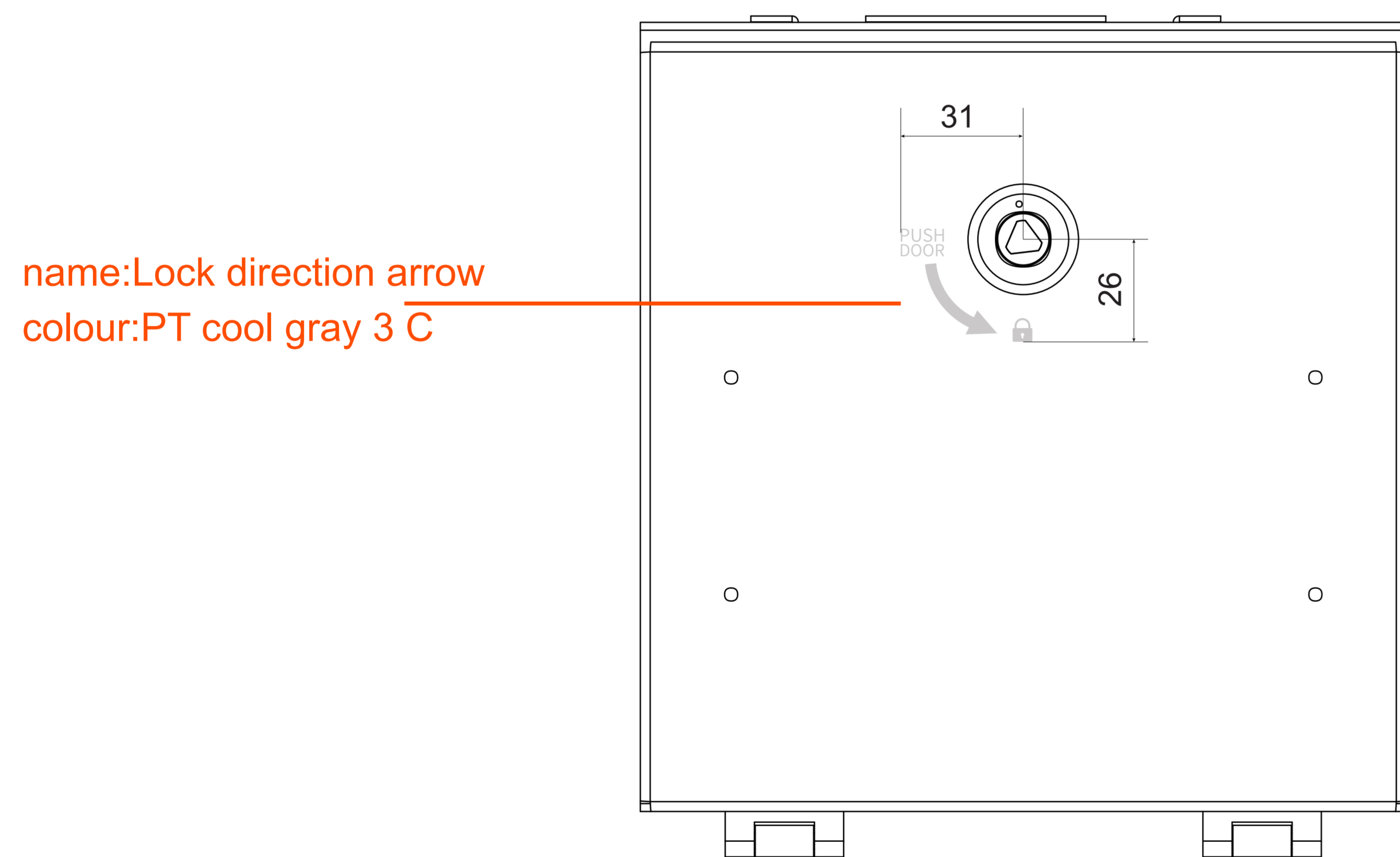

## Marking on the side of the right meter box

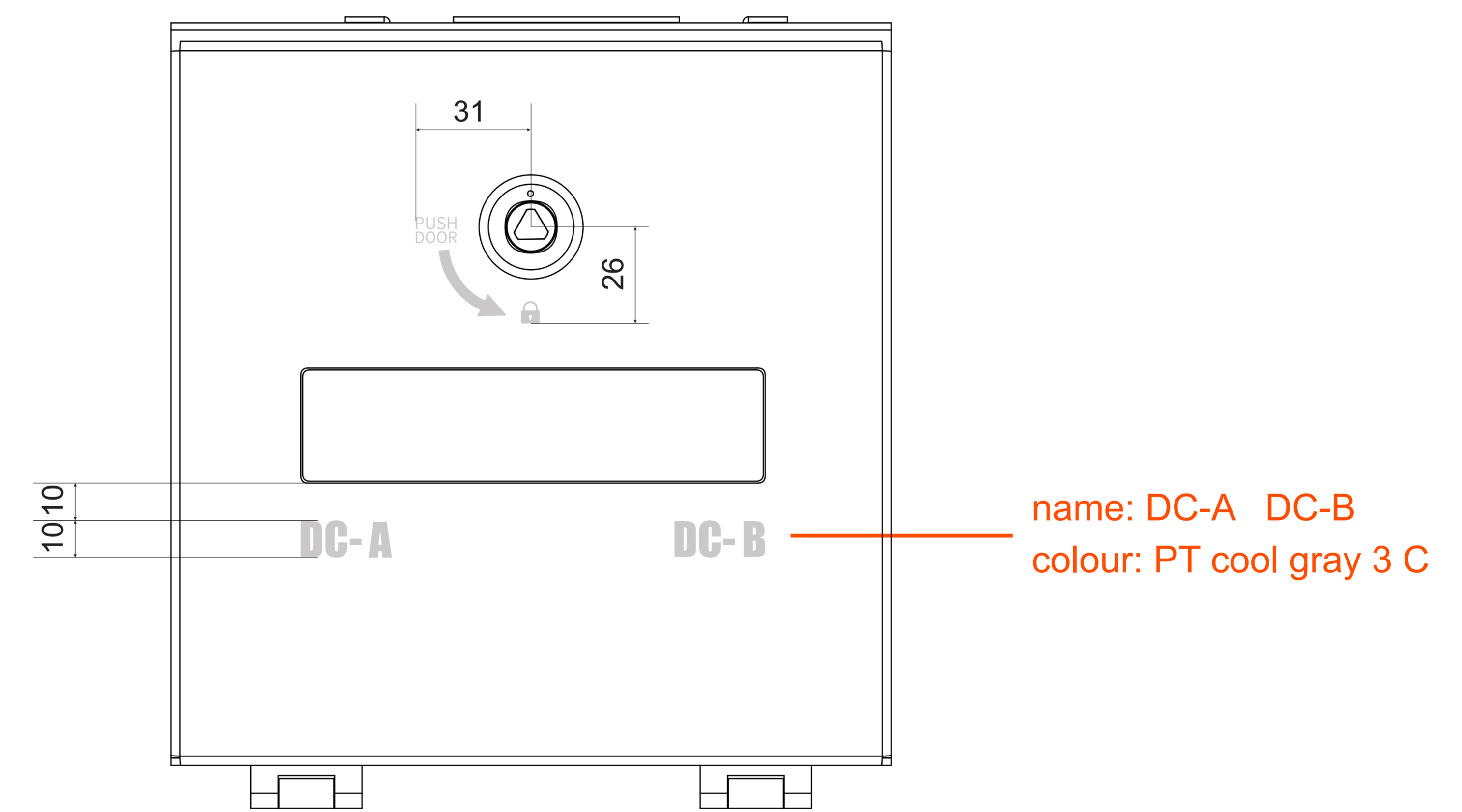

# Marking on the door panel of the cable outlet

name: Lock direction arrow  
colour: PT cool gray 3 C



# marking of the gun base

name: marking of the AB gun base  
colour: PT cool gray 3 C

